

# Submission of Supplemental Projects for Inclusion in the Local Plan

# ATSI Transmission Zone

**Need Number:** ATSI-2018-009  
**Process Stage:** Submission of Supplemental Project for Inclusion in the Local Plan – 03/18/2020  
**Previously Presented:** Need - 09/28/2018  
 Solution – 10/26/2018

**Project Driver(s):**  
*Operational Flexibility and Efficiency*

**Specific Assumption Reference(s)**  
 Add / Expand Bus Configuration

- Reduce amount of exposed potential local load loss during contingency conditions.
- Build New Transmission Line**
- Improve system reliability under contingency conditions.
  - Reduce the amount of potential local load loss during contingency conditions.

**CONTINUED NEXT SLIDE...**

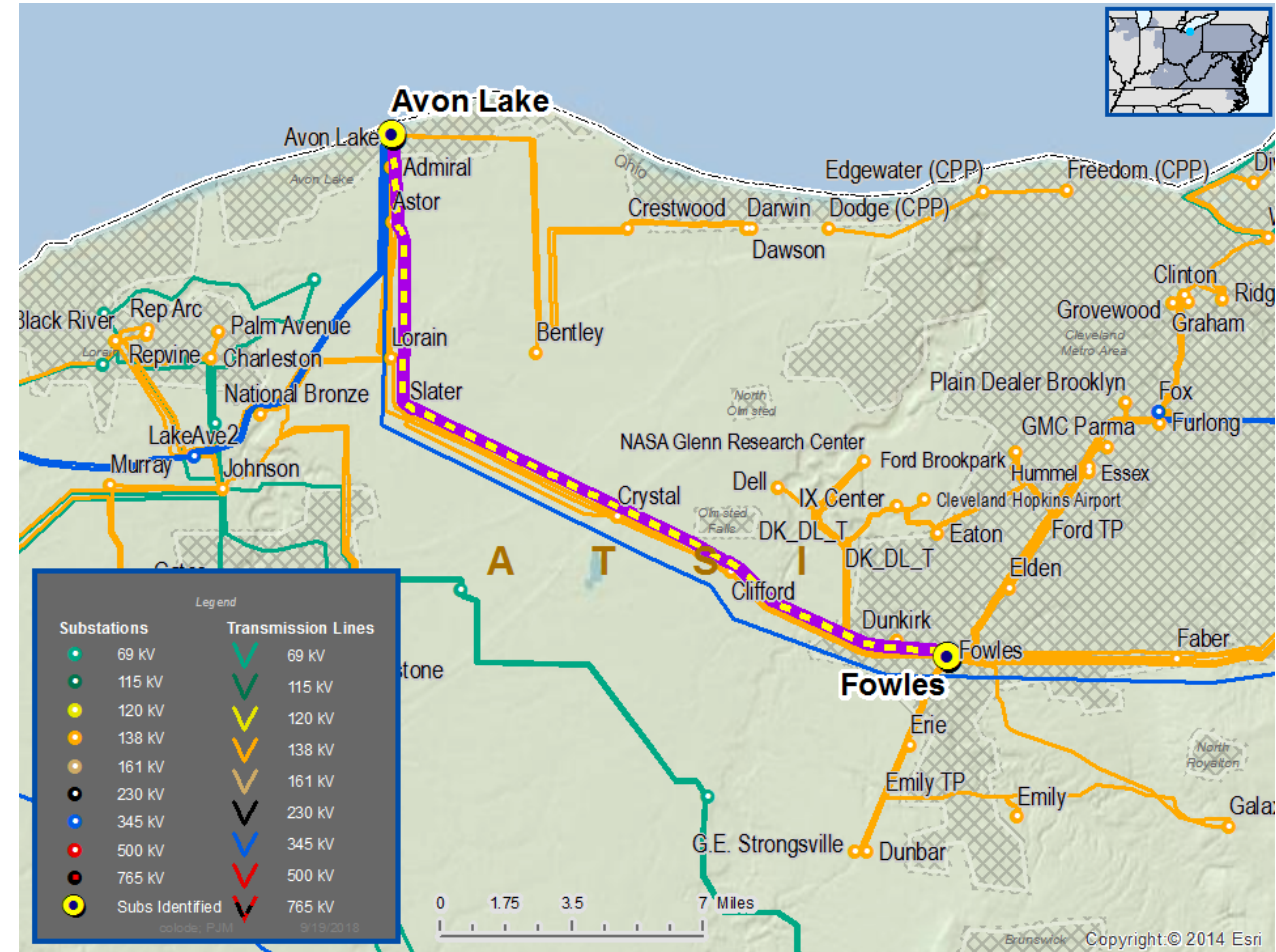

**Need Number:** ATSI-2018-009 (Continued)  
**Process Stage:** Submission of Supplemental Project for Inclusion in the Local Plan – 03/18/2020  
**Previously Presented:** Need - 09/28/2018  
 Solution – 10/26/2018

**CONTINUED FROM PREVIOUS SLIDE...**

**Problem Statement**

**Avon-Fowles 138 kV Q1 and Q3 Line Load at Risk**

- Reduce the amount of local load loss at risk and mitigate non-planning criteria voltage concerns on the > 100 kV system under contingency conditions.
  - Loss of Avon-Fowles Q1 138kV line (“B\_LINE1\_NR\_006”) and path-end outage of the Avon-Fowles Q3 138 line.
  - Results in the potential loss of approximately 60 MWs and 14,000 customers.
  - Results in the potential low voltage (0.91 p.u.) at Dawson 138kV Substation
  
- Or
  - Common tower outage Avon-Fowles Q1 138kV line and the Avon-Fowles Q3 138 line (“C5-TWL-NR005”).
  - Results in the consequential load loss of approximately 237 MWs and 68,200 customers.

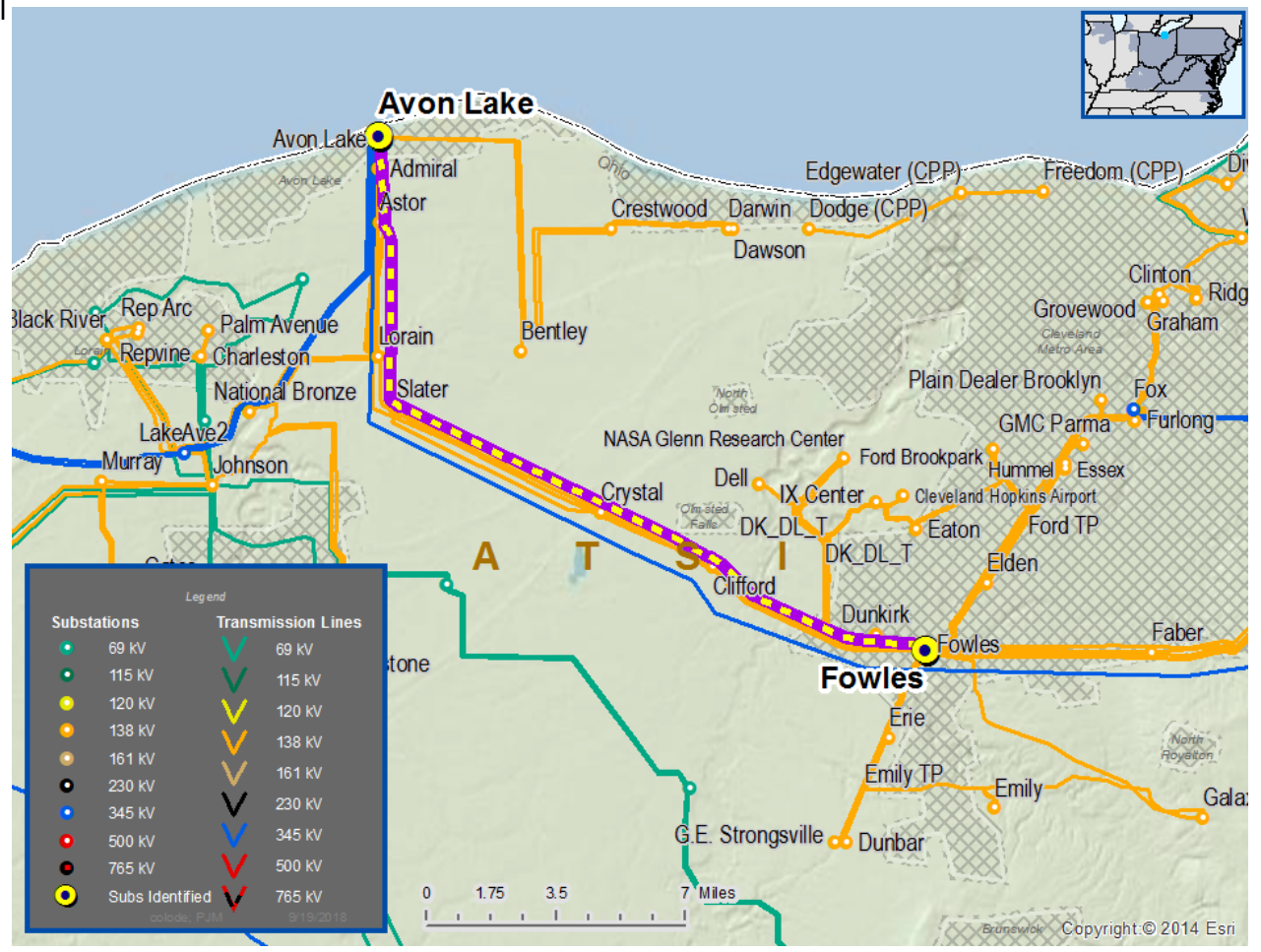

# ATSI Transmission Zone

**Need Number:** ATSI-2018-009 (Continued)

**Process Stage:** Submission of Supplemental Project for Inclusion in the Local Plan – 03/18/2020

**Previously Presented:** Need - 09/28/2018  
Solution – 10/26/2018

**Proposed Solution:**

**Avon-Clinton Install 138kV Double Circuit Corridor**

- Construct double circuit lines (~ 12 miles) from Dawson to Clinton with 795 ACSR conductor; utilize existing lines that are build for future 138kV expansion for part of the new double circuit. New conductor rating is 278 MVA SN / 339 MVA SE
- Expand Dawson substation to a 6-breaker ring bus.
  - Avon-Dawson #1 and Avon-Dawson #2 138 kV Lines
  - Dawson-New Clinton Substation # 1 and Dawson-New Clinton Substation #2 138kV lines.
  - Connect 2 – 138 / 36 kV load transformers
- Build a new substation near Clinton substation to convert Clinton to a breaker and half bus scheme, and incorporate the new Avon-Clinton 138 kV lines into the scheme. The breaker and half scheme will have 4 strings (12 breakers total).
- Create two new line exits at Avon to incorporate the new Clinton lines.
- Rearrange Grovewood taps to eliminate common tower contingency issues by tapping one transformer to the new Avon-Clinton 138 kV line.

**Alternatives Considered:**

- Create two new line exits at Avon for dedicated 138kV radial lines to feed Dawson.

**Estimated Project Cost:** \$57.1M

**Projected IS Date:** 12/31/2022

**Status:** Conceptual

**Supplemental Project ID:** s1987

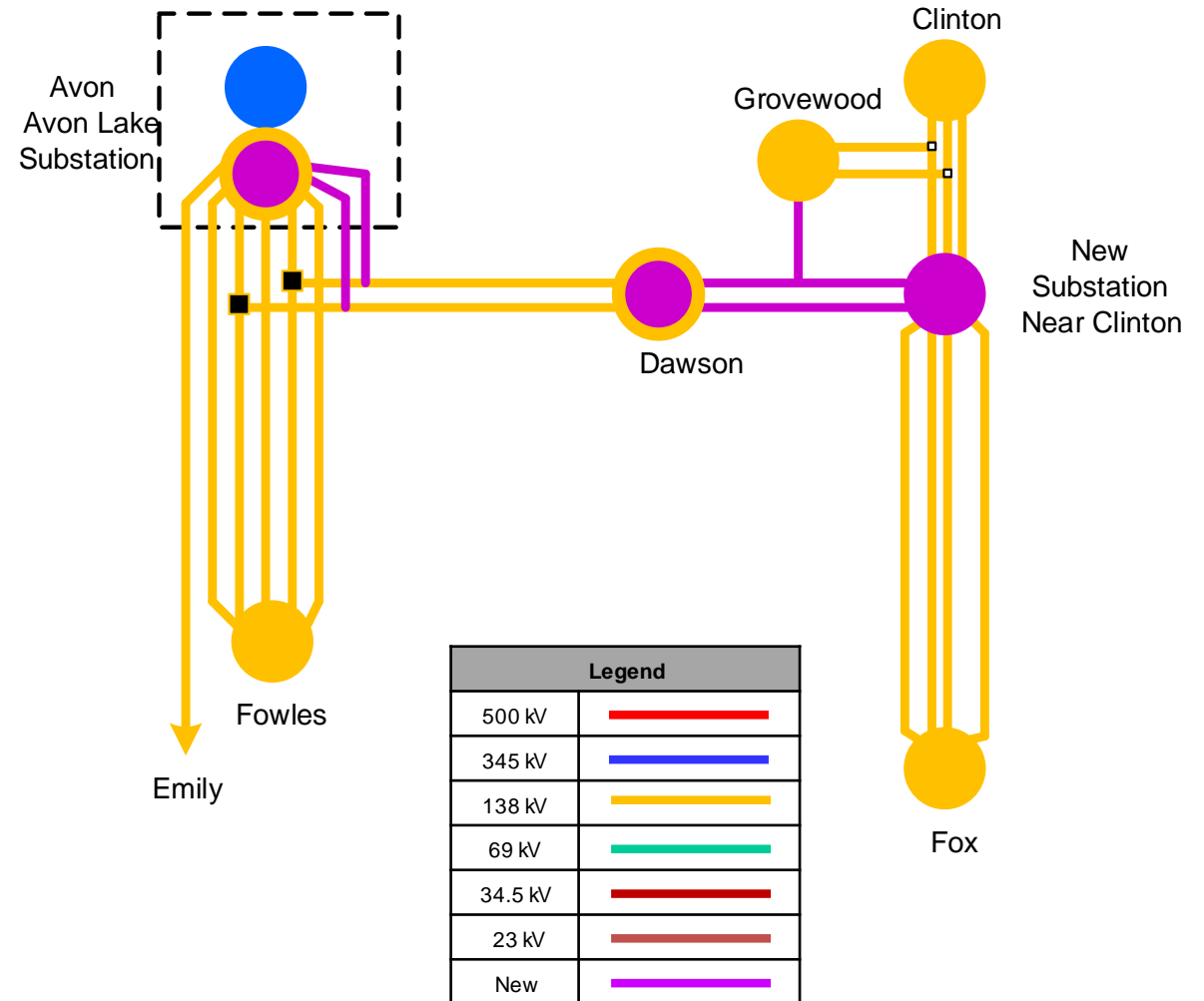

# ATSI Transmission Zone

**Need Number:** AT SI-2018-021

**Process Stage:** Submission of Supplemental Project for Inclusion in the Local Plan – 03/18/2020

**Previously Presented:** Need - 11/29/2018  
Solution – 02/20/2019

**Project Driver(s):**  
*Customer Service*

**Specific Assumption Reference(s)**  
New customer connection request will be evaluated per FirstEnergy’s “Requirements for Transmission Connected Facilities” document and “Transmission Planning Criteria” document.

**Problem Statement**  
New Customer Connection - A customer requested 69 kV service for load of approximately 10 MVA near the Medina-Medina industries 69 kV line.

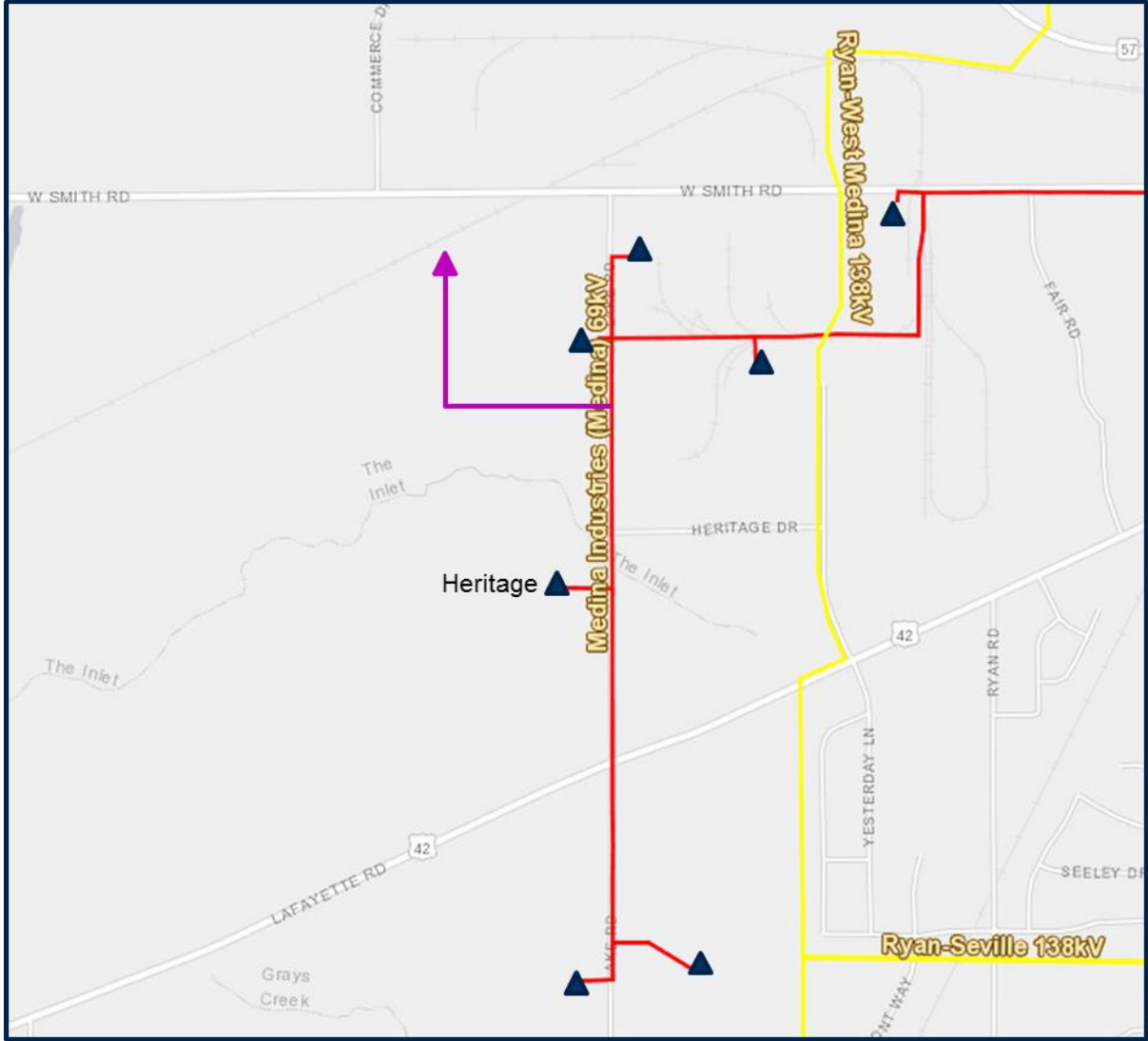

# ATSI Transmission Zone

**Need Number:** AT SI-2018-021

**Process Stage:** Submission of Supplemental Project for Inclusion in the Local Plan – 03/18/2020

**Previously Presented:** Need - 11/29/2018  
Solution – 02/20/2019

**Proposed Solution:**

- Tap the Medina-Medina Industries 69 kV line and extend a 69 kV line (approximately 0.4 miles) to the proposed customer site (match existing conductor size)
- Install in-line sectionalizing switches at the tap location.

**Alternatives Considered:**

- None (obligation to serve)

**Estimated Project Costs:** \$1.4M

**Projected IS Date:** 10/01/2019

**Status:** In-Service

**Supplemental Project ID:** s1872

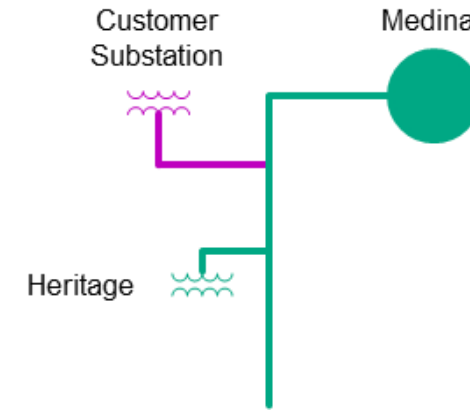

Legend	
500 kV	
345 kV	
138 kV	
69 kV	
34.5 kV	
23 kV	
New	



# ATSI Transmission Zone M-3 Process

## Warrendale (Pine) 69 kV Line Rebuild

**Need Number:** ATSI-2019-051  
**Process Stage:** Submission of Supplemental Project for Inclusion in the Local Plan – 03/18/2020  
**Previously Presented:** Need – 02/20/2019  
Solution – 04/23/2019

**Supplemental Project Driver(s):**  
*Equipment Material Condition, Performance, and Risk*

**Specific Assumption Reference(s)**  
Assessment of existing transmission lines for equipment characteristics that are at, or beyond their existing service life, or contain components that are obsolete.

- Aged or deteriorated wood pole transmission line structures.
- Negatively impact customer outage frequency and/or durations.
- Demonstrate an increasing trend in maintenance findings and/or costs

### Problem Statement

#### Pine-Warrendale 69 kV Condition Assessment

- Warrendale-Richard segment of the line (approximately 3.6 miles of the 6.42 mile line) has been identified as obsolete and deteriorated equipment.
  - Damaged conductor identified along the line.
  - Construction is mostly 42 year old construction; poor inspection results.
- Customers and load at risk: 6,135 customers and 22 MWs of load.
- The Pine-Warrendale 69 kV line has experienced 4 outages in the past five years.

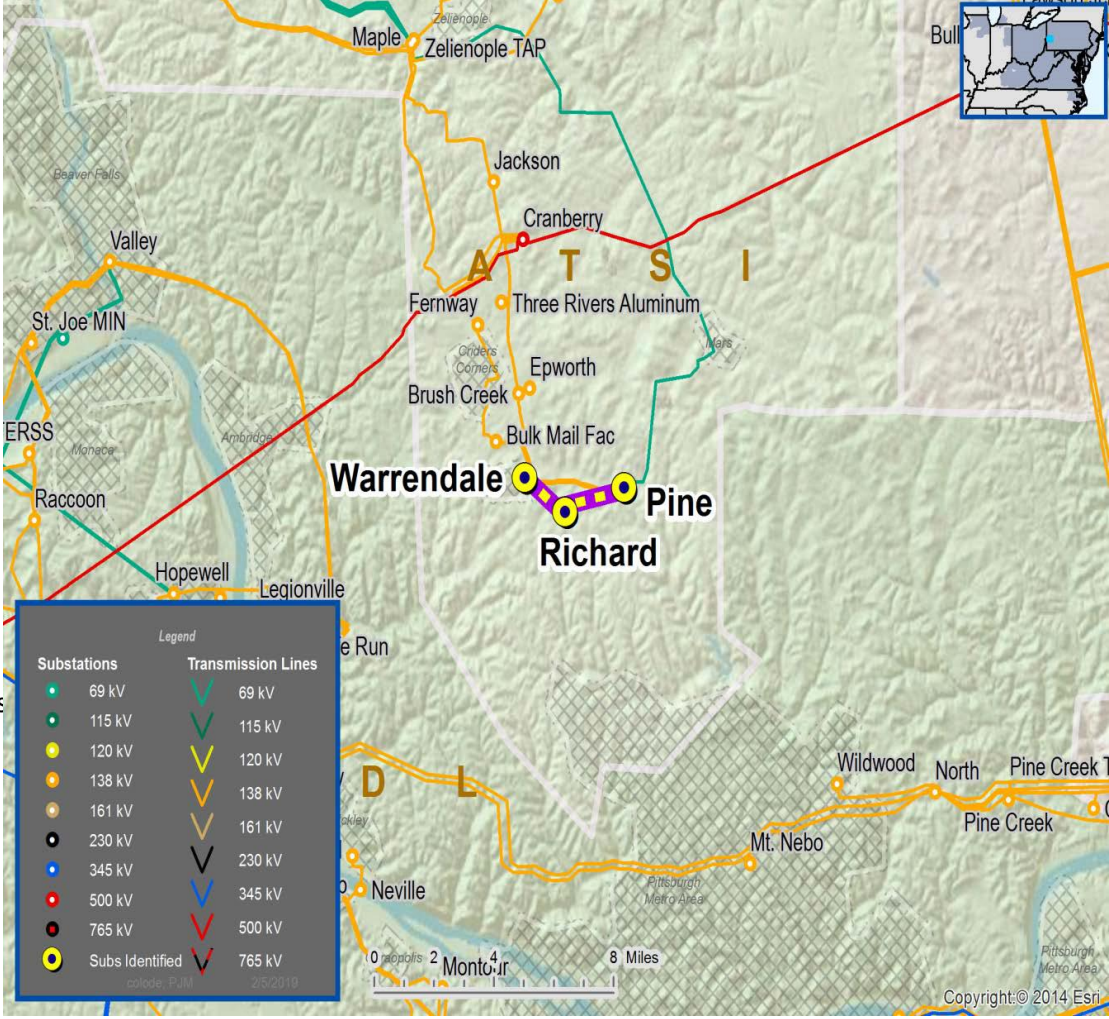

# ATSI Transmission Zone M-3 Process

## Warrendale (Pine) 69 kV Line Rebuild

**Need Number:** ATSI-2019-051  
**Process Stage:** Submission of Supplemental Project for Inclusion in the Local Plan – 03/18/2020  
**Previously Presented:** Need – 02/20/2019  
 Solution – 04/23/2019

**Proposed Solution:**

**Warrendale (Pine) 69 kV Line Rebuild**

- Rebuild/reconductor approximately 3.6 miles of the existing Warrendale (Pine) 69 kV Line (Warrendale - Richard line segment).
- Replace four line switches (A-157, A-218, A-6071, and A-6072) due to age and obsolescence.
- Estimated Project Cost: \$7.5 M

**Transmission Line Ratings:**

- Existing line rating: 133 MVA SN / 163 MVA SE
- New line rating: 139 MVA SN / 169 MVA SE

**Alternatives Considered:**

- Maintain existing condition and elevated risk of failure

**Projected In-Service:** 3/15/2020

**Status:** Engineering

**Supplemental Project ID:** s2067

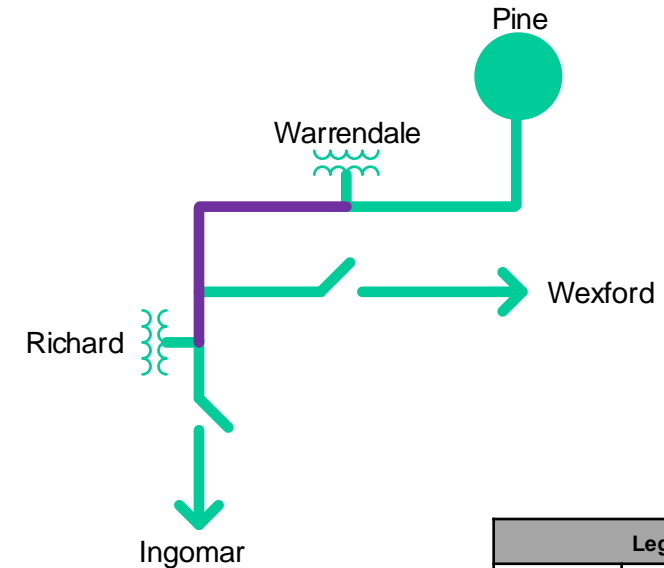

Legend	
500 kV	
345 kV	
138 kV	
69 kV	
34.5 kV	
23 kV	
New	



# ATSI Transmission Zone M-3 Process

## Ottawa-West Fremont #2 138 kV Switch Upgrade

**Need Number:** ATSI-2019-054  
**Process Stage:** Submission of Supplemental Project for Inclusion in the Local Plan – 03/18/2020  
**Previously Presented:** Need – 03/25/2019  
 Solution – 05/20/2019

**Supplemental Project Driver(s):**  
*Equipment Material, Condition, Performance and Risk*  
*Operational Flexibility and Efficiency*  
*Infrastructure Resilience*

**Specific Assumption Reference(s)**

**Global Considerations**

- System reliability and performance
- Substation / Line equipment limits

**Problem Statement**

Ottawa-West Fremont#2 138 kV Equipment and Tap Connection

- The existing KPF switches A-13135 and A-13136 are obsolete and no longer supported by the manufacturer. The existing customer tap connection (tapped between switch A-13135 and switch A-13136) on the Ottawa-West Fremont #2 138 kV line requires a 270 degree turn and crosses under both the Ottawa-West Fremont #1 and Ottawa-West Fremont #2 138 kV lines which creates operational maintenance constraints.

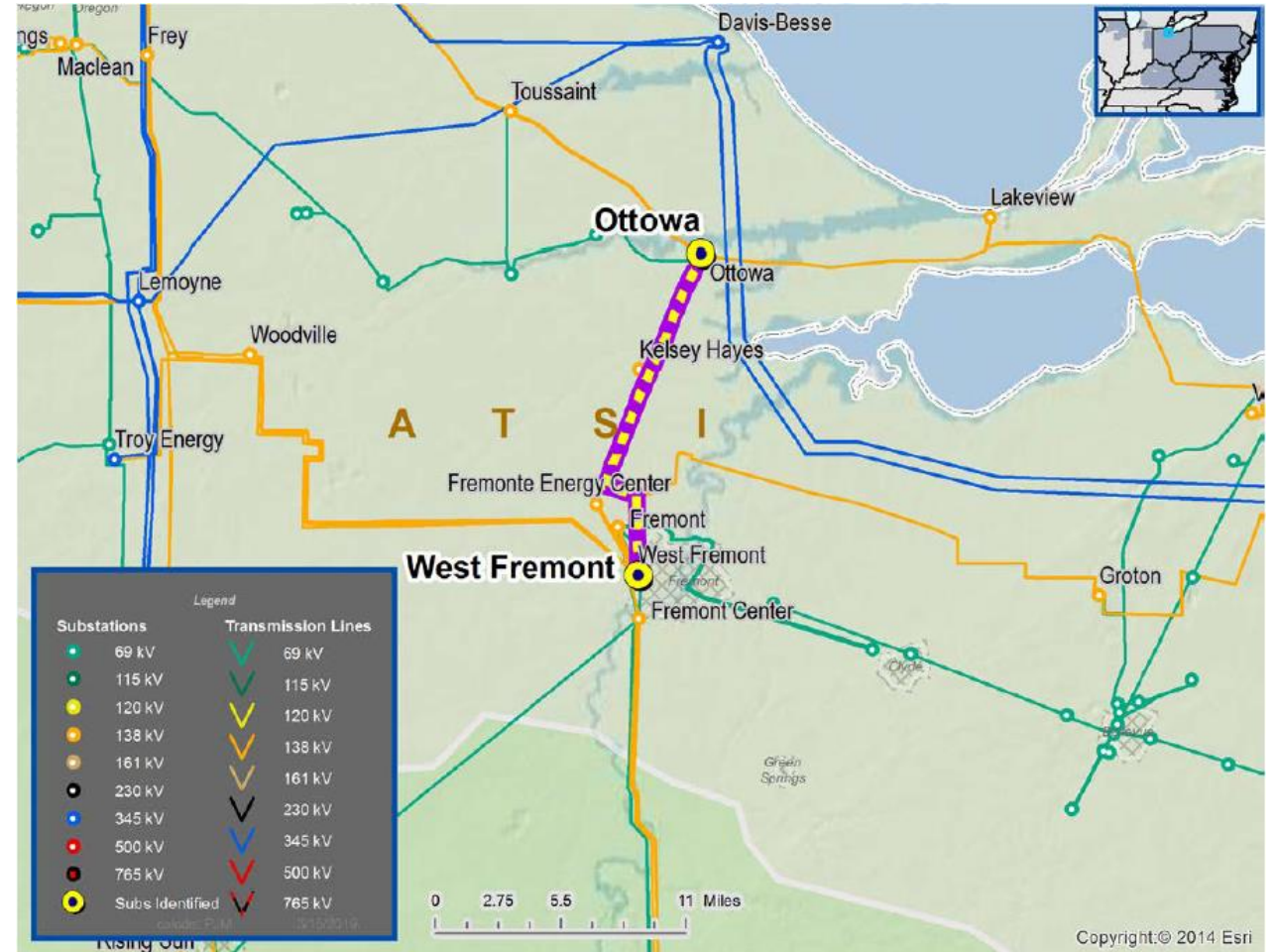

Copyright: © 2014 Esri

# ATSI Transmission Zone M-3 Process

## Ottawa-West Fremont #2 138 kV Switch Upgrade

**Need Number:** ATSI-2019-054  
**Process Stage:** Submission of Supplemental Project for Inclusion in the Local Plan – 03/18/2020  
**Previously Presented:** Need – 03/25/2019  
 Solution – 05/20/2019

### Potential Solution:

Replace switches A-13135P and A-13136 and install SCADA. Transfer customer tap connection and new switches A-13135P and A-13136 onto the Ottawa-West Fremont #1 138 kV line from the existing Ottawa-West Fremont #2 138 kV line to eliminate the 270 degree turn which crosses under both the Ottawa-West Fremont #1 and Ottawa-West Fremont #2 138 kV lines creating operational maintenance constraints.

Estimated Project Cost \$0.7M

### Alternatives Considered:

Maintain existing condition with an elevated risk of failure and continued operational maintenance constraints.

**Projected In-Service:** 11/06/2020

**Status:** Conceptual

**Supplemental Project ID:** s2068

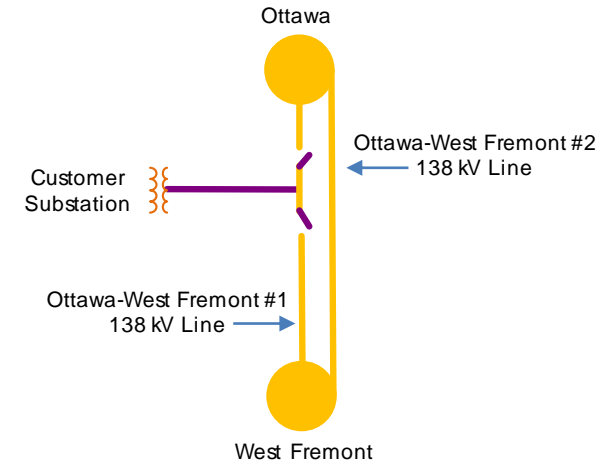

Legend	
500 kV	
345 kV	
138 kV	
69 kV	
34.5 kV	
23 kV	
New	

**Need Number:** ATSI-2019-057  
**Process Stage:** Submission of Supplemental Project for Inclusion in the Local Plan – 03/18/2020  
**Previously Presented:** Need – 05/20/2019  
 Solution – 07/24/2019

**Supplemental Project Driver(s):**  
*Customer Service*

**Specific Assumption Reference(s)**

New customer connection request evaluated per FirstEnergy’s “Requirements for Transmission Connected Facilities” document and “Transmission Planning Criteria” document.

**Problem Statement**

New Customer Connection - A customer requested 138 kV transmission service approximately 75 MVA of load be connected to the Ashtabula 138 kV substation, approximately 1.7 miles from the customer substation.

**Requested In-Service Date:** 06/01/2020

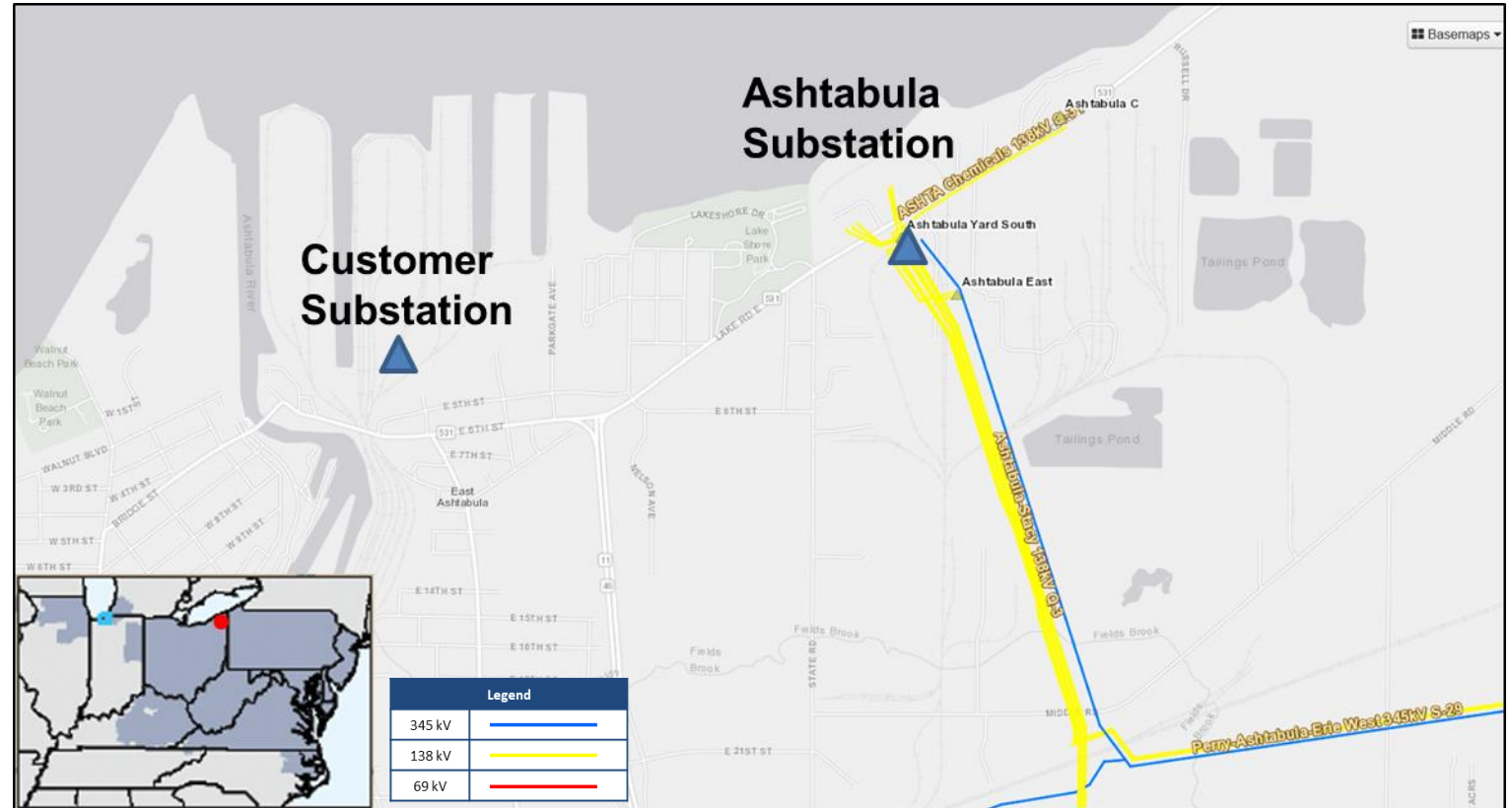

# ATSI Transmission Zone M-3 Process New 138 kV Service Connection - Solution

**Need Number:** ATSI-2019-057  
**Process Stage:** Submission of Supplemental Project for Inclusion in the Local Plan – 03/18/2020  
**Previously Presented:** Need – 05/20/2019  
 Solution – 07/24/2019

**Proposed Solution:**

- Build a new 138 kV line (1.5 miles) from Ashtabula substation to the new customer substation with fiber communications for relay coordination.
- Relocate the existing Ashta 138 kV line terminal to make room for the new customer line exit
- Install one 138 kV circuit breaker and protective relaying at Ashtabula substation for the new customer line exit
- New 138 kV circuit ratings: 200 MVA SN/ 242 MVA SE

Estimated Project Cost: \$ 6.2M

**Alternatives Considered:**

- None (obligation to serve)

**Projected In-Service:** 06/01/2020  
**Project Status:** Conceptual  
**Model:** 2018 Series 2023 Summer RTEP 50/50  
**Supplemental Project ID:** s2064

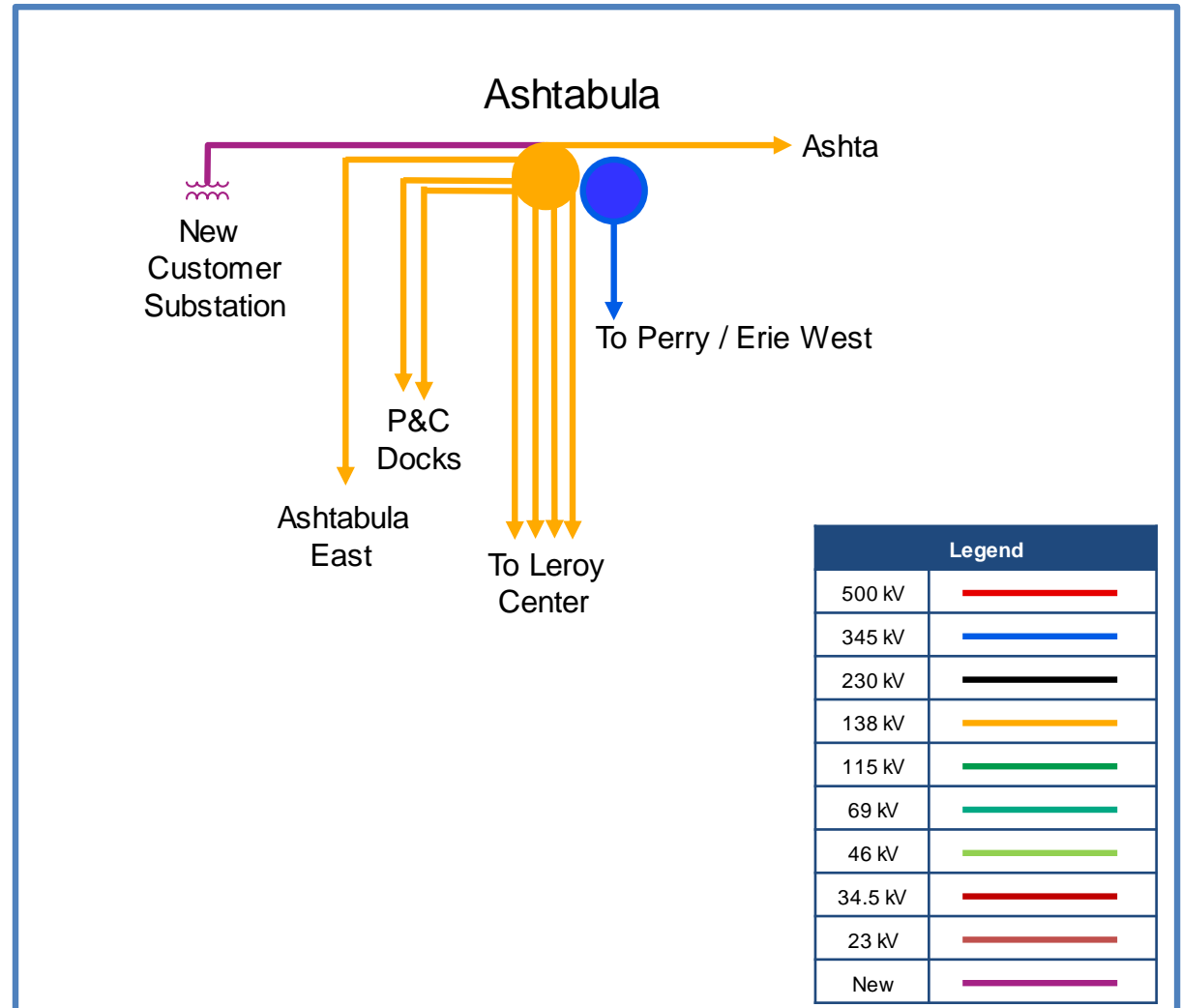

**Need Number:** ATSI-2019-058  
**Process Stage:** Submission of Supplemental Project for Inclusion in the Local Plan – 03/18/2020  
**Previously Presented:** Need – 07/24/2019  
 Solution – 11/22/2019

**Project Driver:**  
*Customer Service*

**Specific Assumption References:**

New customer connection request evaluated per FirstEnergy’s “Requirements for Transmission Connected Facilities” document and “Transmission Planning Criteria” document.

**Problem Statement:**

New Customer Connection

- A customer requested a 138 kV transmission service for a 138/12.47 kV substation with approximately 10.0 MVA of load near Lemoyne substation.

**Requested In-Service Date:** 03/01/2020

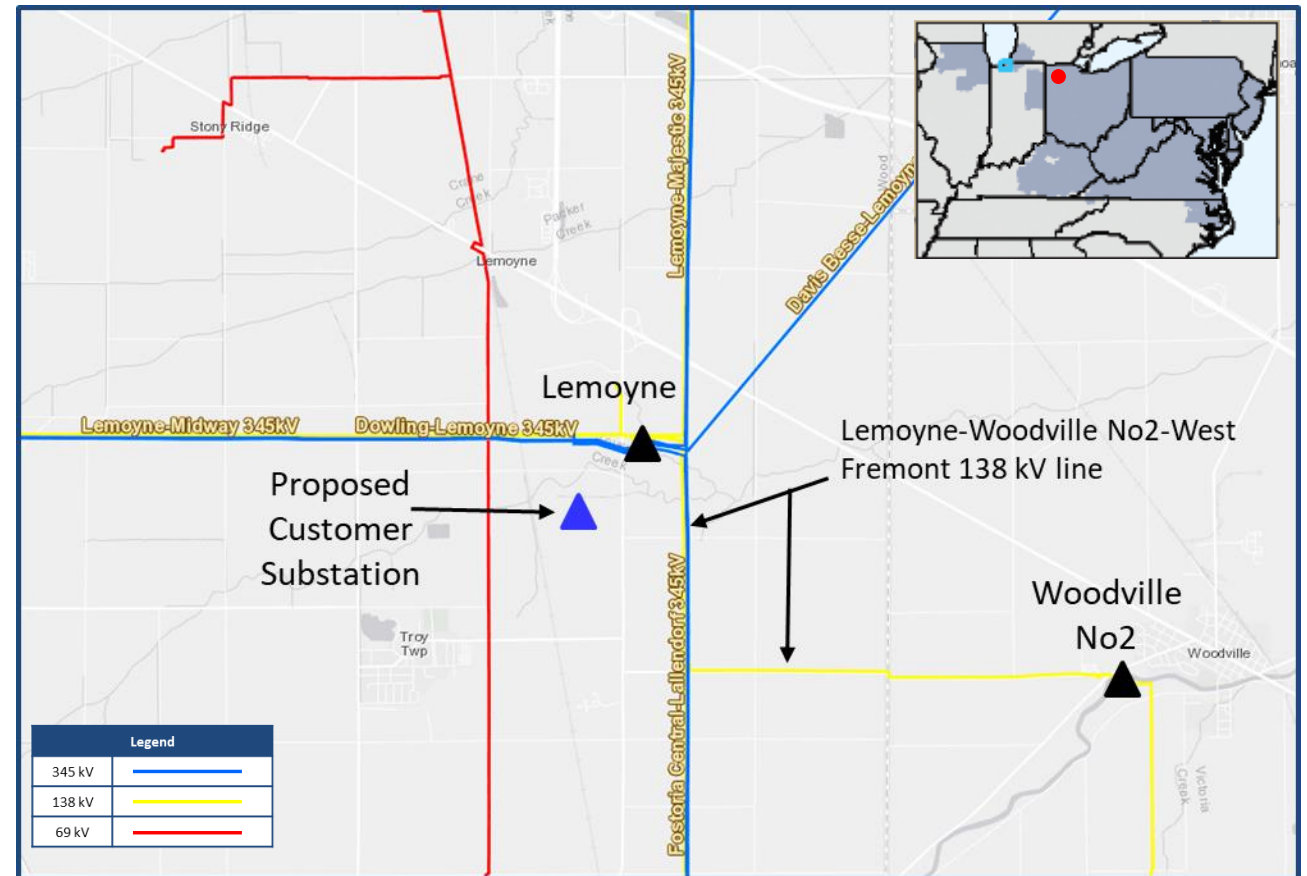



# ATSI Transmission Zone M-3 Process New 138 kV Service Connection - Solution

**Need Number:** ATSI-2019-058  
**Process Stage:** Submission of Supplemental Project for Inclusion in the Local Plan – 03/18/2020  
**Previously Presented:** Need – 07/24/2019  
 Solution – 11/22/2019

**Proposed Solution:**

- Tap the Lemoyne-Woodville No. 2 138 kV line approximately 1.1 miles from Lemoyne (FE) substation and build a 138 kV line, approximately 0.3 miles, to the proposed customer substation.
- Install two (2) 138 kV in-line switches with SCADA control on both sides of the new tap connection
- Install one (1) 138 kV in-line switch on the line extension towards the customer substation

Estimated Project Cost: \$ 1.6M

**Alternatives Considered:**

- None (obligation to serve)

**Projected In-Service:** 06/01/2020  
**Project Status:** Conceptual  
**Model:** 2018 Series 2023 Summer RTEP 50/50  
**Supplemental Project ID:** s2121

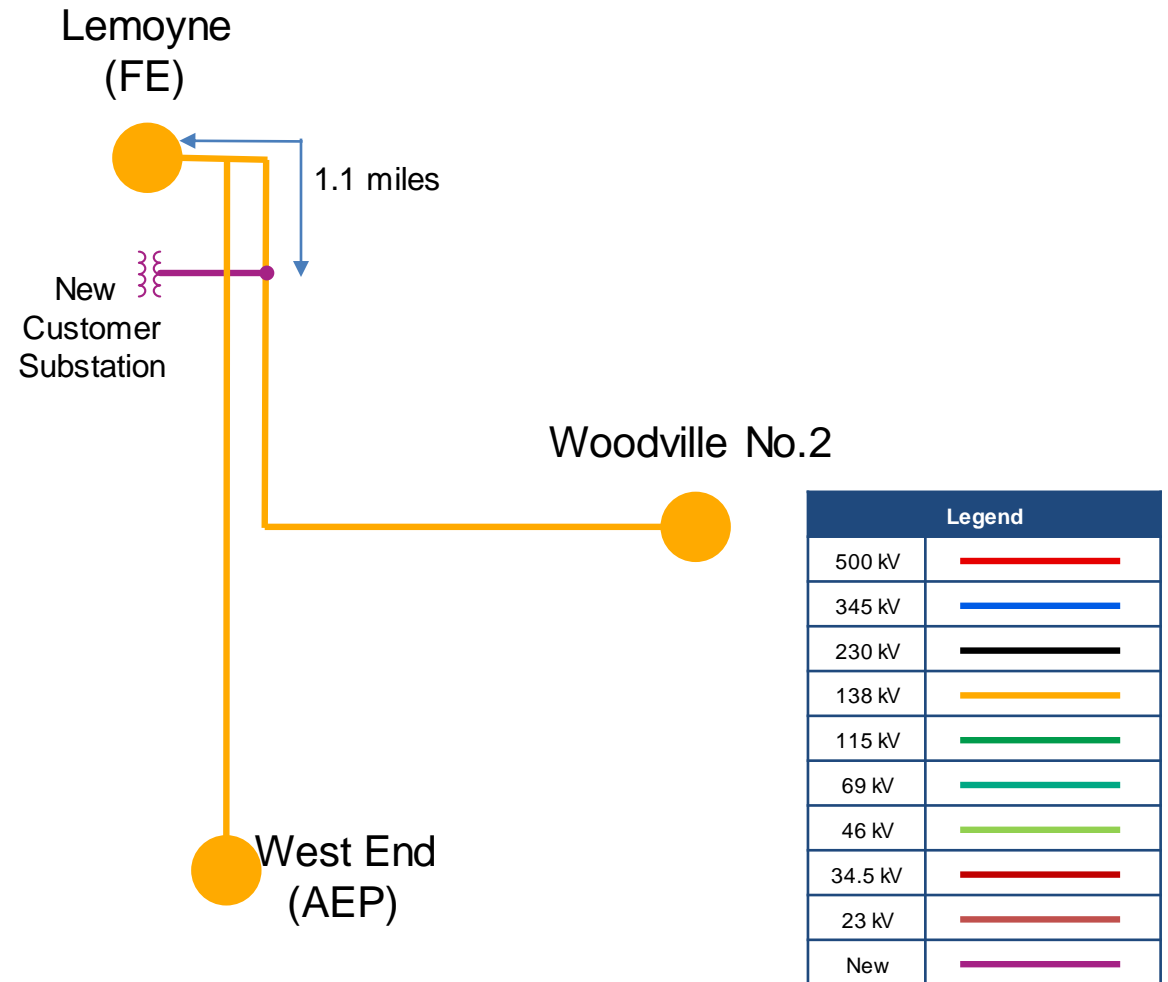

**Need Number:** ATSI-2019-Multiple (See next slide)  
**Process Stage:** Submission of Supplemental Project for Inclusion  
in the Local Plan – 03/18/2020  
**Previously Presented:** Need – 07/24/2019  
Solution – 11/22/2019

**Project Driver:**  
*Equipment Material Condition, Performance and Risk*

**Specific Assumption References:**

*Line Condition Rebuild/Replacement*

- Age/condition of wood pole transmission line structures
- Age/condition of steel tower or steel pole transmission line structures
- Age/condition of transmission line conductors

*System Performance Projects*

- Substation/line equipment limits

**Problem Statement:**

- Line sections are exhibiting deterioration, increasing maintenance needs.
- Transmission line is approaching end of life
- Transmission line ratings are limited by terminal equipment.

Continued on next page...

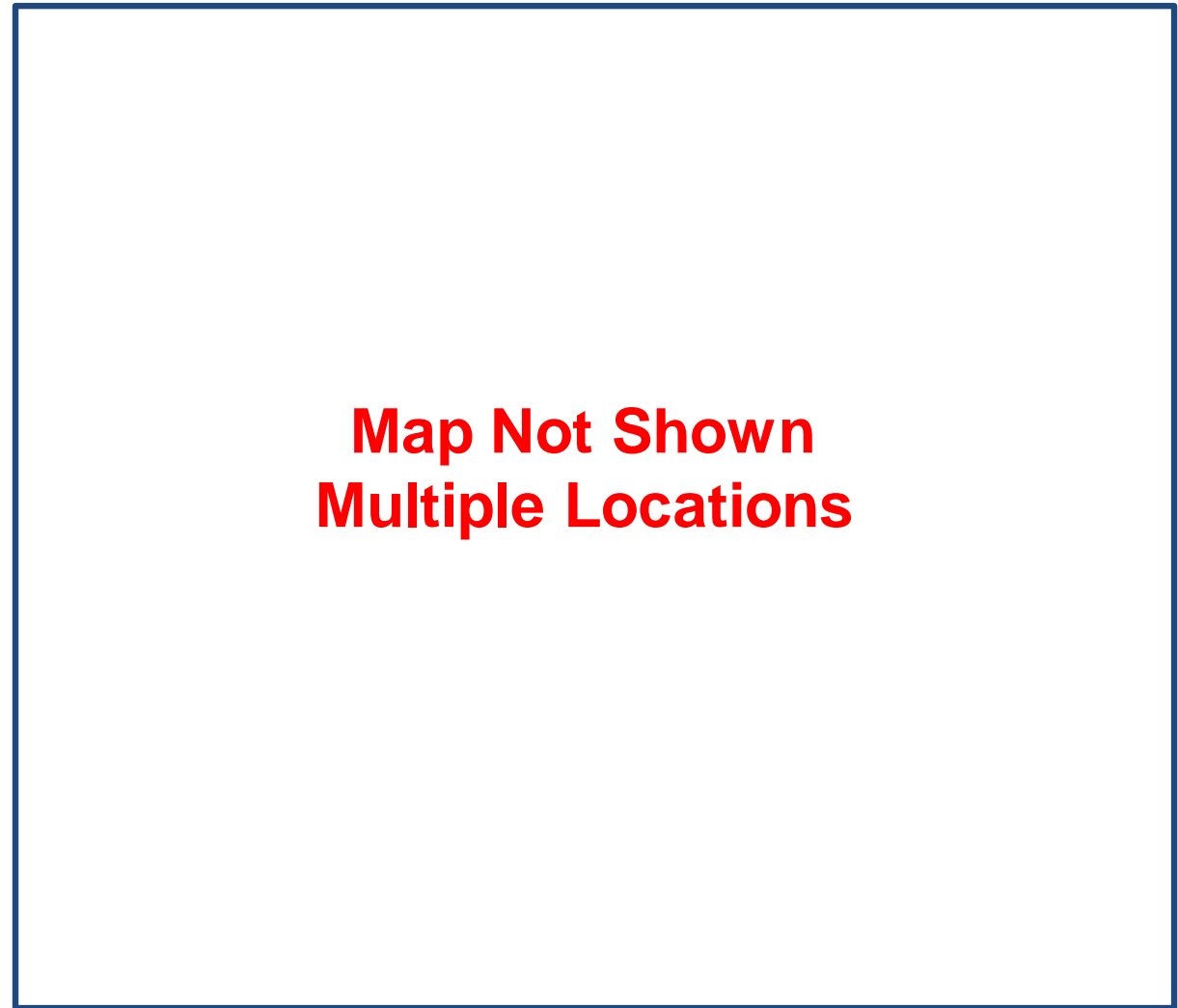

**Problem Statement:**

ATSI-2019-	Transmission Line / Substation Locations	Existing Circuit MVA Rating (SN / SE)	Existing Conductor MVA Rating (SN / SE)	Limiting Terminal Equipment	Length of Line (miles)	Identified Structures (end of life / total)	Failure reasons
<b>Darrow – Shalersville 69 kV Line (11.2 Miles)</b>							
-061	Darrow – Little Tikes Tap	76 / 92	76 / 92	-	0.7	59 / 178 (33% Failure Rate)	Decay, woodpecker holes, and age
	Little Tikes Tap – Streetsboro	76 / 92	76 / 92	-	4.3		
	Streetsboro – Streetsboro	76 / 92	76 / 92	-	1.8		
	Streetsboro – Aurora Plastics Tap	82 / 103	100 / 121	Sw itch	2.2		
	Aurora Plastics Tap – Shalersville	100 / 104	100 / 121	Relay	2.2		

Continued on next page...



... Continued from previous page

**Problem Statement:**

ATSI-2019-	Transmission Line / Substation Locations	Existing Circuit MVA Rating (SN / SE)	Existing Conductor MVA Rating (SN / SE)	Limiting Terminal Equipment	Length of Line (miles)	Identified Structures (end of life / total)	Failure reasons
<b>Clark – Navistar 69 kV Line (11.3 Miles)</b>							
-062	Clark – Ferncliff 69kV Line	76 / 92	76 / 92	-	2.9	93 / 185 (50% Failure Rate)	Age, w oodpecker holes, grounding not present.
	Ferncliff – Ridgewood 69kV Line	76 / 92	76 / 92	-	1.0		
	Ridgewood – Navistar 69kV Line	45 / 54	45 / 54	-	7.4		

**Proposed Solution:**

ATSI-2019	Transmission Line / Substation Locations	New MVA Line Rating (SN / SE)	Proposed Solution	Estimated Costs (\$ M)	Target ISD	Supplemental Project ID
ATSI-2019-061	Darrow – Shalersville 69 kV Line (11.2 Miles)	100 / 121	<ul style="list-style-type: none"> <li>Rebuild approx. 6.7 miles of wood pole construction from Darrow substation to Streetsboro substation.</li> <li>Rehab balance of line (approx. 4.5 miles) and correct open maintenance items</li> <li>Replace two (2) line switches to conform with present standards</li> <li>Upgrade relaying at remote terminal ends.</li> </ul>	\$9.3M	12/30/2023	s2122
ATSI-2019-062	Clark – Navistar 69 kV Line (11.3 Miles)	76 / 92	<ul style="list-style-type: none"> <li>Rebuild approx. 3.9 miles of wood pole construction from Clark substation to Ridgewood substation tap; utilize existing conductor.</li> <li>Rebuild approx. 3.1 miles of wood pole construction from structure 65 to Navistar substation; reconductor to match existing conductor.</li> <li>Rehab balance of line (approximately 4.3 miles) including select pole replacements and structure/tower repairs.</li> <li>Upgrade terminal end equipment</li> </ul>	\$11.2M	12/30/2023	s2123

**Alternatives Considered:**

- Maintain existing condition and elevated risk of failure

**Projected In-Service:** See table

**Project Status:** Conceptual (All Projects)

**Model:** N/A

**No changes in topology; No bubble diagram required.**



**Need Number:** ATSI-2019-Mutiple (See next slide)  
**Process Stage:** Submission of Supplemental Project for Inclusion in the Local Plan – 03/18/2020  
**Previously Presented:** Need – 07/24/2019  
Solution – 11/22/2019

**Project Driver:**  
*Equipment Material Condition, Performance and Risk*

**Specific Assumption References:**

*Global Factors*

- System reliability and performance
- Substation / line equipment limits

*Upgrade Relay Schemes*

- Relay schemes that have a history of misoperation
- Obsolete and difficult to repair communication equipment (DTT, Blocking, etc.)
- Communication technology upgrades
- Bus protection schemes

**Problem Statement:**

- FirstEnergy has identified protection schemes using a certain vintage of relays and communication equipment that have a history of misoperation.
  - Proper operation of the protection scheme requires all the separate components perform adequately during a fault
  - In many cases the protection equipment cannot be repaired due to a lack of replacement parts and available expertise in the outdated technology.
  - Transmission line ratings are limited by terminal equipment.
- Continued on next page...



...Continued from previous page

**Problem Statement**

ATSI-2019-	Transmission Line / Substation Locations	Existing Line/Terminal Equipment MVA Rating (SN / SE)	Existing Conductor/Transformer MVA Rating (SN / SE)	Limiting Terminal Equipment
-063	Avery Substation No.1 Transformer 138/69 kV	153 / 153	177 / 209	Line Relay, Substation Conductor
-064	Cloverdale – Canton Central 138kV Line	161 / 194 (S) 182 / 210 (W)	161 / 194 (S) 182 / 230 (W)	Line Relay (Winter Ratings)
-065	Evergreen – Ivanhoe 138kV Line	200 / 242 (S) 226 / 249 (W)	200 / 242 (S) 226 / 286 (W)	Line Relay (Winter Rating)
-066	Hoytdale – New Castle #2 138kV Line	329 / 373	425 / 522	Relay, Substation Conductor, Disconnect Switch
-067	Crossland – Shenango #2 138kV	215 / 215	278 / 339	Relay, Substation Conductor

**Proposed Solution:**

ATSI-2019-	Transmission Line / Substation Locations	New MVA Line Rating (SN / SE)	Proposed Solution	Estimated Costs (\$ M)	Target ISD	Supplemental Project ID
-063	Avery Substation No.1 Transformer 138/69 kV	177 / 209	<ul style="list-style-type: none"> <li>Replace transformer relaying on Avery #1 transformer, substation conductor, and upgrade disconnect switch.</li> </ul>	\$ 0.6	12/31/2020	s2124
-064	Cloverdale – Canton Central 138kV Line	161 / 194 (S) 182 / 230 (W)	<ul style="list-style-type: none"> <li>Replace line relaying on the Cloverdale terminal end; upgrade existing disconnect switches and replace one air break switch; replace substation conductors at Cloverdale; replace terminal end breaker at Cloverdale (B100) with SF6 breaker due to existing condition.</li> </ul>	\$ 0.8	06/01/2021	s2125
-065	Evergreen – Ivanhoe 138kV Line	200 / 242 (S) 226 / 286 (W)	<ul style="list-style-type: none"> <li>Replace line relaying at Evergreen and Ivanhoe terminal ends; upgrade existing disconnect switches, CCVTs, wave-traps, and terminal end breakers at Evergreen (B23) and Ivanhoe (B8) with SF6 breakers due to existing condition</li> </ul>	\$ 2.4	04/01/2021	s2126
-066	Hoytdale – New Castle #2 138kV Line	425 / 522	<ul style="list-style-type: none"> <li>Replace line relaying on the Hoytdale and New Castle terminal ends; upgrade existing disconnect switches at Hoytdale and one air break switch at New Castle; replace substation conductors at Hoytdale and New Castle; replace terminal end breaker at Hoytdale (B14) with SF6 breaker due to existing condition.</li> </ul>	\$ 0.5	12/31/2021	s2127
-067	Crossland – Shenango #2 138kV	278 / 339	<ul style="list-style-type: none"> <li>Replace line relaying on Crossland-Shenango terminal ends; replace disconnect switches and substation conductors at Shenango and Crossland, replace one air break switch and terminal end breakers at Shenango (B14 and B18) due to existing condition.</li> </ul>	\$ 1.0	12/01/2020	s2128

**Alternatives Considered:**

- Maintain existing condition and elevated risk of failure

**Projected In-Service:** See table

**Project Status:** Conceptual (All Projects)

**Model:** N/A

**No changes in topology; No bubble diagram required.**

**Need Number:** ATSI-2019-Mutiple (See next slide)  
**Process Stage:** Submission of Supplemental Project for Inclusion in the Local Plan – 06/08/2020  
**Previously Presented:** Need Meeting – 11/22/2019  
Solution Meeting – 03/19/2020

**Project Driver:**  
*Equipment Material Condition, Performance and Risk*

**Specific Assumption References:**

*Global Factors*

- System reliability and performance
- Substation / line equipment limits

*Upgrade Relay Schemes*

- Relay schemes that have a history of misoperation
- Obsolete and difficult to repair communication equipment (DTT, Blocking, etc.)
- Communication technology upgrades
- Bus protection schemes

**Problem Statement:**

- FirstEnergy has identified protection schemes using a certain vintage of relays and communication equipment that have a history of misoperation.
- Proper operation of the protection scheme requires all the separate components perform adequately during a fault
- In many cases the protection equipment cannot be repaired due to a lack of replacement parts and available expertise in the outdated technology.
- Transmission line ratings are limited by terminal equipment.

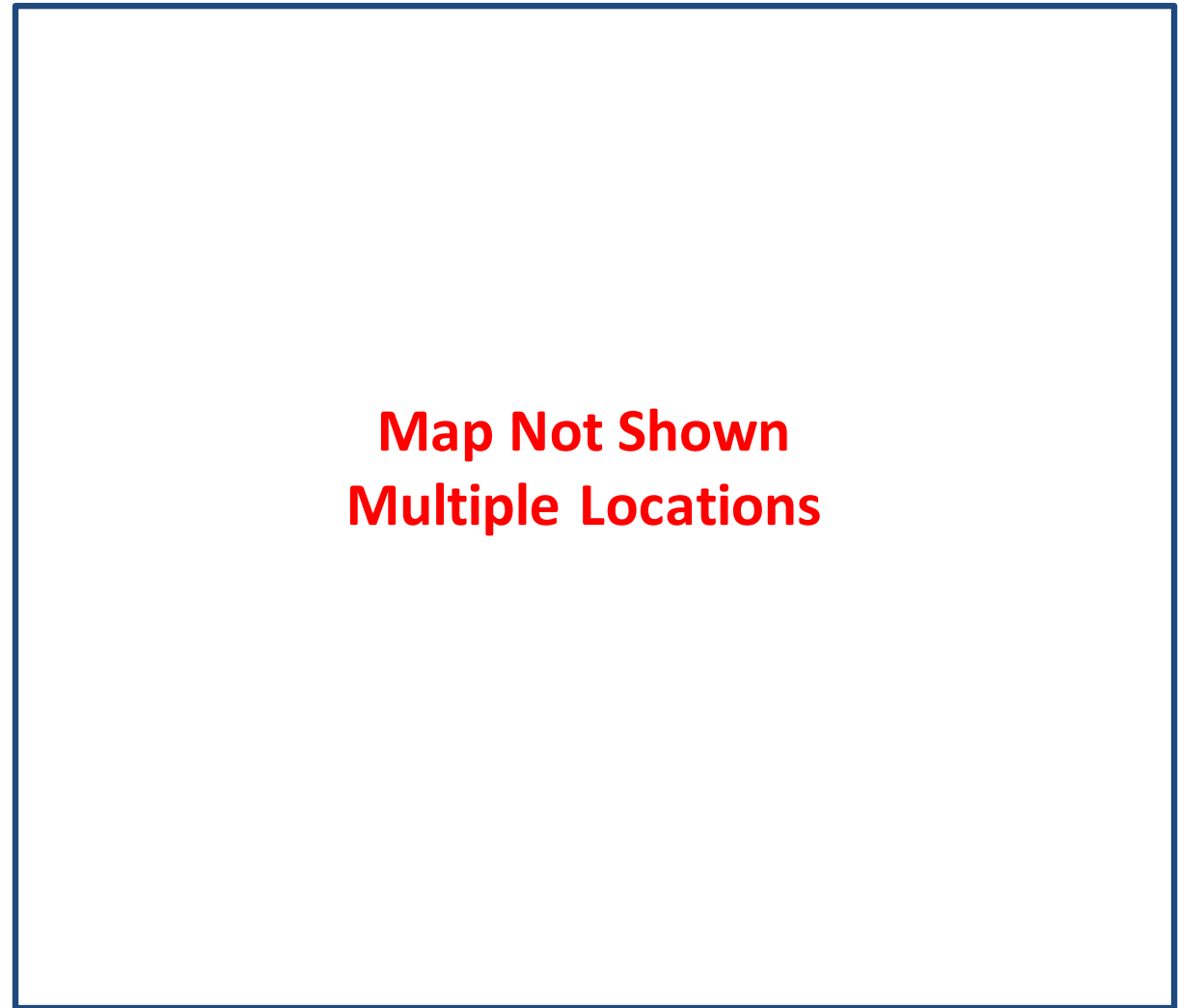

...Continued from previous page

ATSI-2019	Transmission Line / Substation Locations	Existing Line/Terminal Equipment MVA Rating (SN / SE)	Existing Conductor/Transformer MVA Rating (SN / SE)	Limiting Terminal Equipment
-072	Eber-Swanton 138 kV Line 1. Eber – Johnson Controls 2. Johnson Controls – Swanton	1. 327 (WN) / 396 (WE) 2. 327 (WN) / 396 (WE)	1. 327 (WN) / 420 (WE) 2. 327 (WN) / 420 (WE)	Substation Conductor (Winter Ratings) @ Swanton
-073	Eastlake-Lloyd 138 kV Q12 Line 1. Eastlake – Liberty 2. Lamont – Lloyd	1. 273 / 287 2. 103 / 132	1. 273 / 332 2. 148 / 151	Substation Conductor, Relay, CTs @ Lloyd
-074	Chamberlin-Hudson East 138 kV Line	226 (WN) / 249 (WE)	226 (WN) / 286 (WE)	Relay (Winter Ratings) @ Chamberlin
-075	Eastlake-Nottingham 138 kV Q11 Line Eastlake – Lamont	324 / 382	324 / 395	Meter, Relay @ Eastlake
-076	Maclean-Lemoyne 138 kV Line	329 / 413	376 / 465	Disconnect Switch @ Maclean
-077	Clinton-CPP 138 kV Line	187 / 222	194 / 237	Substation Conductor @ Clinton
-078	Eastlake-Jordon 138 kV Q14 Line 1. Eastlake – Marble 2. Judi – Jordan	1. 324 / 382 2. 265 / 316	1. 324 / 395 2. 273 / 332	Substation Conductor, Meter, Relay @ Eastlake & Jordon
-079	Beaver-West Lorain 345 kV Line	1370 / 1646	1560 / 1900	Substation Conductor, Disconnect Switch @ Beaver



...Continued from previous page

ATSI-2019	Transmission Line / Substation Locations	New MVA Line Rating (SN / SE)	Proposed Solution	Estimated Costs (\$ M)	Target ISD
-072	Eber-Swanton 138 kV Line 1. Eber – Johnson Controls 2. Johnson Controls – Swanton	1. 327 (WN) / 420 (WE) 2. 327 (WN) / 420 (WE)	Replace the line relaying for the Eber-Swanton 138 kV line, the substation conductor (Winter Ratings), wave trap, line tuner and line disconnect at Swanton and Eber and line CCVT at Eber.	1.1	06/24/2020
-073	Eastlake-Lloyd 138 kV Q12 Line 1. Eastlake – Liberty 2. Lamont – Lloyd	1. 273 / 332 2. 148 / 151	At Eastlake replace the Q-12 circuit breaker, line disconnect switch, relaying, line terminal arresters, and line CVTs. At Lloyd replace the substation conductor, and Eastlake-Lloyd Q-12 line relaying.	0.9	12/01/2021
-074	Chamberlin-Hudson East 138 kV Line	226 (WN) / 286 (WE)	Replace the line and breaker failure relays, disconnect switches, line metering, CCVTs (due to condition) at Chamberlin and Hudson. Replace rod gaps with arresters at Hudson. Replace breaker B-59, and substation jumper conductors at Chamberlin.	1.5	11/19/2020
-075	Eastlake-Nottingham 138 kV Q11 Line Eastlake – Lamont	324/395	At Eastlake, replace the Q-11 circuit breaker, line disconnect switch, line and breaker failure relaying, line terminal arresters, and line CCVT's. At Nottingham, replace substation conductor, line and breaker failure relaying and line CCVTs.	1.1	4/06/2022

**Alternatives Considered:**

- Maintain existing condition and elevated risk of failure

**Projected In-Service:** See table

**Project Status:** Engineering (All Projects)

**Model:** N/A

**No changes in topology; No bubble diagram required.**

...Continued from previous page

ATSI-2019	Transmission Line / Substation Locations	New MVA Line Rating (SN / SE)	Proposed Solution	Estimated Costs (\$ M)	Target ISD
-076	Maclean-Lemoyne 138 kV Line	376/465	At Maclean, replace terminal end breaker B13202, disconnect switches, line and breaker failure relaying, carrier transceiver and monitor, metering, substation conductors, CCVT and add surge arresters. At Lemoyne, replace terminal end breaker B13219, disconnect switches, line and breaker failure relaying, substation conductors and add carrier monitor, and surge arresters.	0.9	12/15/2020
-077	Clinton-CPP 138 kV Line	194/237	At Clinton, replace the circuit breaker, line disconnect switch, relaying for interconnection to CPP (Ridge Rd.) and breaker failure, substation conductor, and install new meter, surge arresters and line side CCVTs.	0.9	11/13/2020
-078	Eastlake-Jordon 138 kV Q14 Line 1. Eastlake – Marble 2. Judi – Jordan	1. 324 / 395 2. 273 / 332	At Eastlake replace line disconnect switch and relaying. At Jordan replace the substation conductor.	0.2	06/01/2021
-079	Beaver-West Lorain 345 kV Line	1560/1900	At Beaver replace bus differential relaying for Interconnection to Generating Company, metering, substation conductor, and disconnect switch.	0.4	12/01/2023

**Alternatives Considered:**

- Maintain existing condition and elevated risk of failure

**Projected In-Service:** See table

**Project Status:** Engineering (All Projects)

**Model:** N/A

**No changes in topology; No bubble diagram required.**

**Need Number:** ATSI-2019-Multiple (See next slide)  
**Process Stage:** Submission of Supplemental Project for Inclusion in the Local Plan – 06/08/2020  
**Previously Presented:** Need Meeting – 11/22/2019  
Solution Meeting – 03/19/2020

**Project Driver:**  
*Equipment Material Condition, Performance and Risk*

**Specific Assumption References:**

*Global Factors*

- System reliability and performance
- Substation / line equipment limits

*Upgrade Relay Schemes*

- Bus protection schemes which rely on remote clearing.
- Protection system with single point of failure.
- Relay schemes that have a history of misoperation.
- Obsolete firmware or software.

**Problem Statement:**

- FirstEnergy has identified protection schemes on networked lines and buses using a certain vintage of relays that have a history of misoperation.
- Schemes protecting these facilities have no local backup so failures impact a larger portion of the system.
- In many cases the protection equipment cannot be repaired due to a lack of replacement parts and available expertise in the outdated technology.
- Transmission line ratings are limited by terminal equipment.

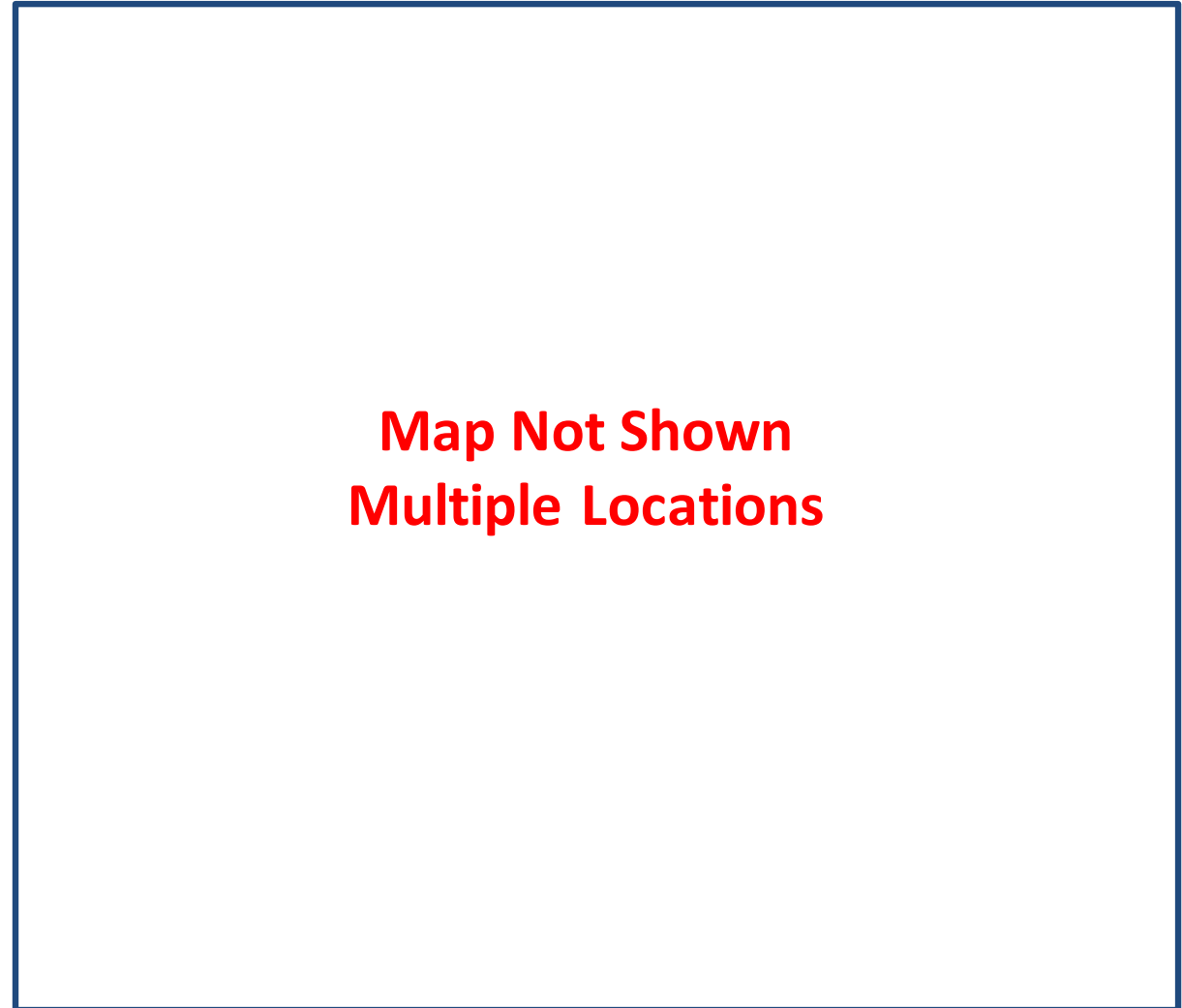

...Continued from previous page

<b>ATSI-2019</b>	<b>Transmission Line / Substation Locations</b>	<b>Existing Line/Terminal Equipment MVA Rating (SN / SE)</b>	<b>Existing Conductor/Transformer MVA Rating (SN / SE)</b>	<b>Limiting Terminal Equipment</b>
- 080	Bluebell 138 kV Bus Protection	100 / 100	164 / 206	Relays @ Bluebell
- 081	Maysville 69 kV Bus Protection	143 / 143	153 / 184	Relays @ Maysville



# ATSI Transmission Zone M-3 Process Bluebell Replace 138 kV Bus Protection - Solution

**Need Number:** ATSI-2019-080  
**Process Stage:** Submission of Supplemental Project for Inclusion in the Local Plan – 06/08/2020  
**Previously Presented:** Need Meeting – 11/22/2019  
 Solution Meeting – 03/19/2020

**Proposed Solution:**

- Replace 138 kV bus protection at Bluebell with dual SEL 487B scheme
- Upgrade substation conductor at Bluebell for the Bluebell-Knox 138 kV Line
- Upgrade substation conductor on the Bluebell #4 138/69 kV T transformer circuit

**Estimated Project Cost:** \$0.96 M

**Transmission Line Ratings:**

- Bluebell 138 kV Bus
  - Before Proposed Solution: 100 MVA SN / 100 MVA SE
  - After Proposed Solution: 164 MVA SN / 206 MVA SE
- Bluebell-Knox 138 kV Line
  - Before Proposed Solution: 153 MVA SN / 199 MVA SE
  - After Proposed Solution: 200 MVA SN / 242 MVA SE
- Bluebell #4 138/69 kV T transformer
  - Before Proposed Solution: 103 MVA SN / 133 MVA SE
  - After Proposed Solution: 188 MVA SN / 221 MVA SE

**No changes in topology;  
No bubble diagram  
required.**

**Alternatives Considered:**

- None

**Projected In-Service:** 12/31/2020  
**Status:** Engineering  
**Model:** 2019 Series 2024 Summer RTEP 50/50

Legend	
500 kV	
345 kV	
138 kV	
69 kV	
34.5 kV	
23 kV	
New	





# ATSI Transmission Zone M-3 Process Maysville Replace 69 kV Bus Protection - Solution

**Need Number:** ATSI-2019-081  
**Process Stage:** Submission of Supplemental Project for Inclusion in the Local Plan – 06/08/2020  
**Previously Presented:** Need Meeting – 11/22/2019  
 Solution Meeting – 03/19/2020

**Proposed Solution:**

- Replace 69 kV bus protection with primary and backup differential
- Add CT to 69 kV breaker B46 for use with new bus protection relaying
- Upgrade substation conductor at Maysville for the Canal (Maysville) 69 kV Line

**Estimated Project Cost:** \$0.22 M

**Transmission Line Ratings:**

- Maysville 69 kV Bus
  - Before Proposed Solution: 143 MVA SN / 143 MVA SE
  - After Proposed Solution: 153 MVA SN / 184 MVA SE
- Maysville-Greenville 69 kV Line segment
  - Before Proposed Solution: 64 MVA SN / 83 MVA SE
  - After Proposed Solution: 80 MVA SN / 96 MVA SE

**Alternatives Considered:**

- None

**Projected In-Service:** 12/31/2020  
**Status:** Engineering  
**Model:** 2019 Series 2024 Summer RTEP 50/50

**No changes in topology;  
No bubble diagram  
required.**

Legend	
500 kV	
345 kV	
138 kV	
69 kV	
34.5 kV	
23 kV	
New	



# ATSI Transmission Zone M-3 Process LTV East Steel Customer - Solution

**Need Number:** ATSI-2019-083  
**Process Stage:** Submission of Supplemental Project for Inclusion in the Local Plan – 06/08/2020  
**Previously Presented:** Need Meeting – 11/22/2019  
Solutions Meeting – 02/21/2020

**Supplemental Project Driver(s):**  
*Customer Service*

### Specific Assumption Reference(s)

Modification of existing customer connection request evaluated per FirstEnergy's "Requirements for Transmission Connected Facilities" document and "Transmission Planning Criteria" document.

### Problem Statement

Existing Customer Connection – Service Modification

- The existing customer requested modification to their current 138 kV transmission service.
- The request is to move some of their existing load from the Harding – Jennings Q13 138 kV line to the Harding – Jennings Q11 138 kV line.

This request is not for a load increase but will result in a system topology change.

**Requested In-Service Date:** 02/01/2020

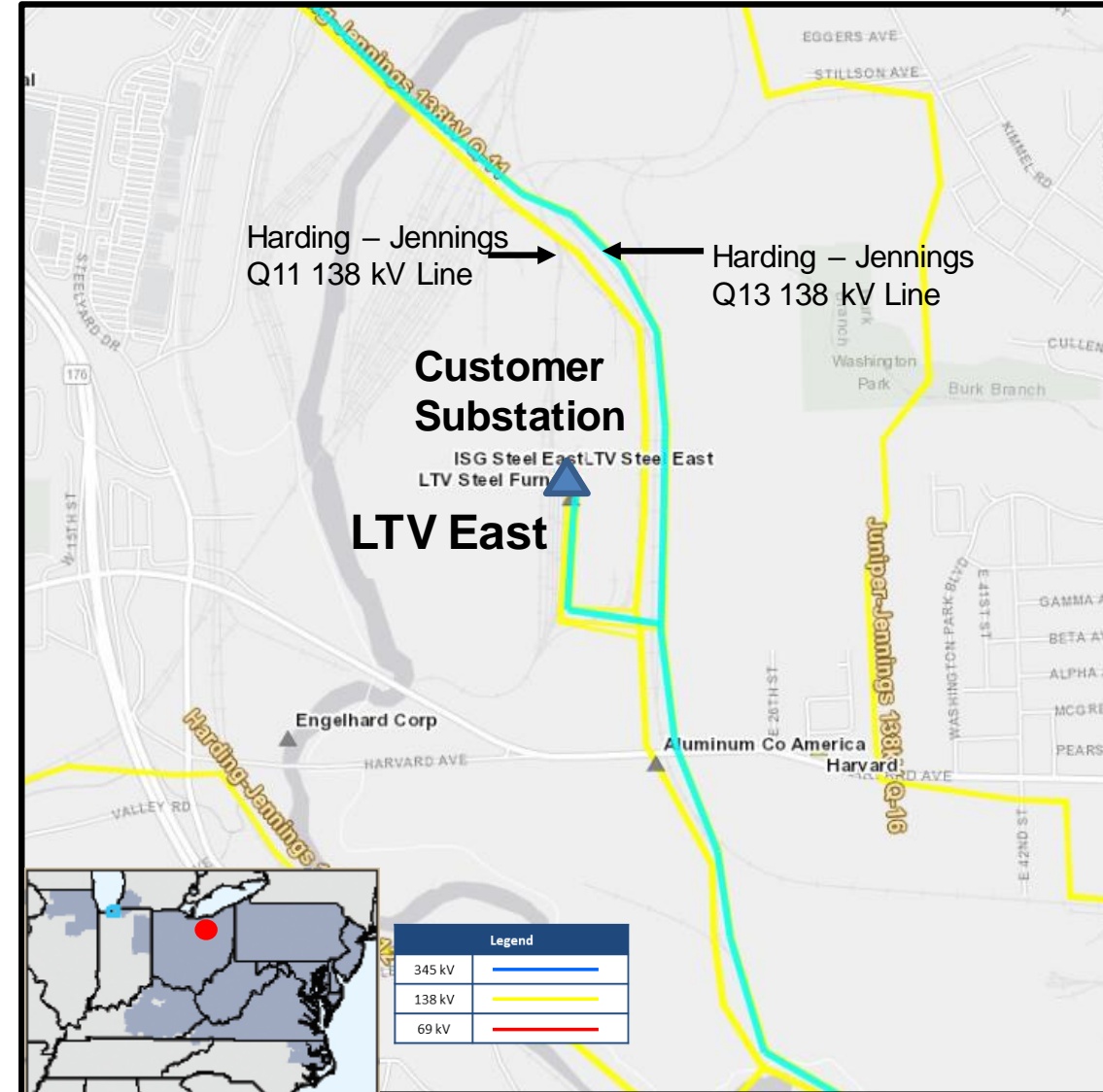



# ATSI Transmission Zone M-3 Process LTV East Steel Customer - Solution

**Need Number:** ATSI-2019-083  
**Process Stage:** Submission of Supplemental Project for Inclusion in the Local Plan – 06/08/2020  
**Previously Presented:** Need Meeting – 11/22/2019  
 Solution Meeting – 02/21/2020

**Proposed Solution:**

- Disconnect transformer #2 from the Harding – Jennings Q13 138 kV line.
- Reconnect transformer #2 to the Harding – Jennings Q11 138 kV line.

**Estimated Project Cost:** \$0

**Alternatives Considered:**

- None (obligation to serve)

**Projected In-Service:** 03/15/2020  
**Status:** Engineering  
**Model:** 2018 Series 2023 Summer RTEP 50/50

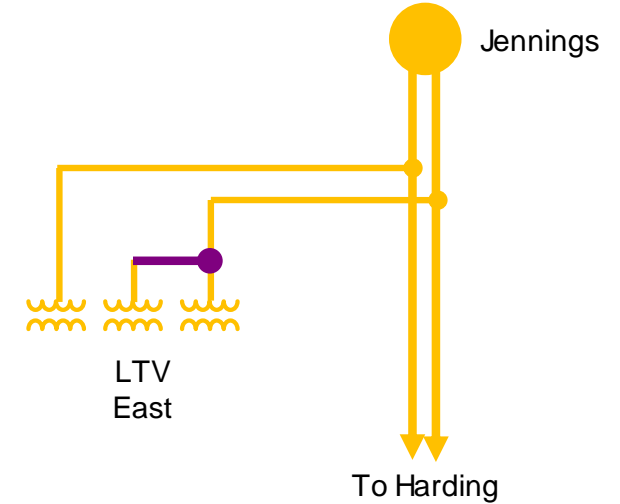

Legend	
500 kV	
345 kV	
138 kV	
69 kV	
34.5 kV	
23 kV	
New	

**Need Number:** ATSI-2019-084

**Process Stage:** Submission of Supplemental Project for Inclusion in the Local Plan – 06/08/2020

**Process Stage:** Need Meeting – 11/22/2019  
Solution Meeting – 03/19/2020

**Supplemental Project Driver(s):**  
*Equipment Material Condition, Performance and Risk*

**Specific Assumption Reference(s)**

*Global*

- Increasing negative trend in maintenance findings and/or costs
- Failure risk, to the extent caused by asset design characteristics, or history industry/company performance data, or application design error
- Expected service life (at or beyond) or obsolescence

*Circuit Breaker and other fault interrupting devices*

- Condition of interrupting media (oil, gas, etc.)

*Switches*

- Blade and jaw assembly
- Switch degradation

*Upgrade Relay Schemes*

- Bus protection schemes which rely on remote clearing
- Protection system with single point of failure
- Relayschemes that have a history of misoperation

Continued on next page...

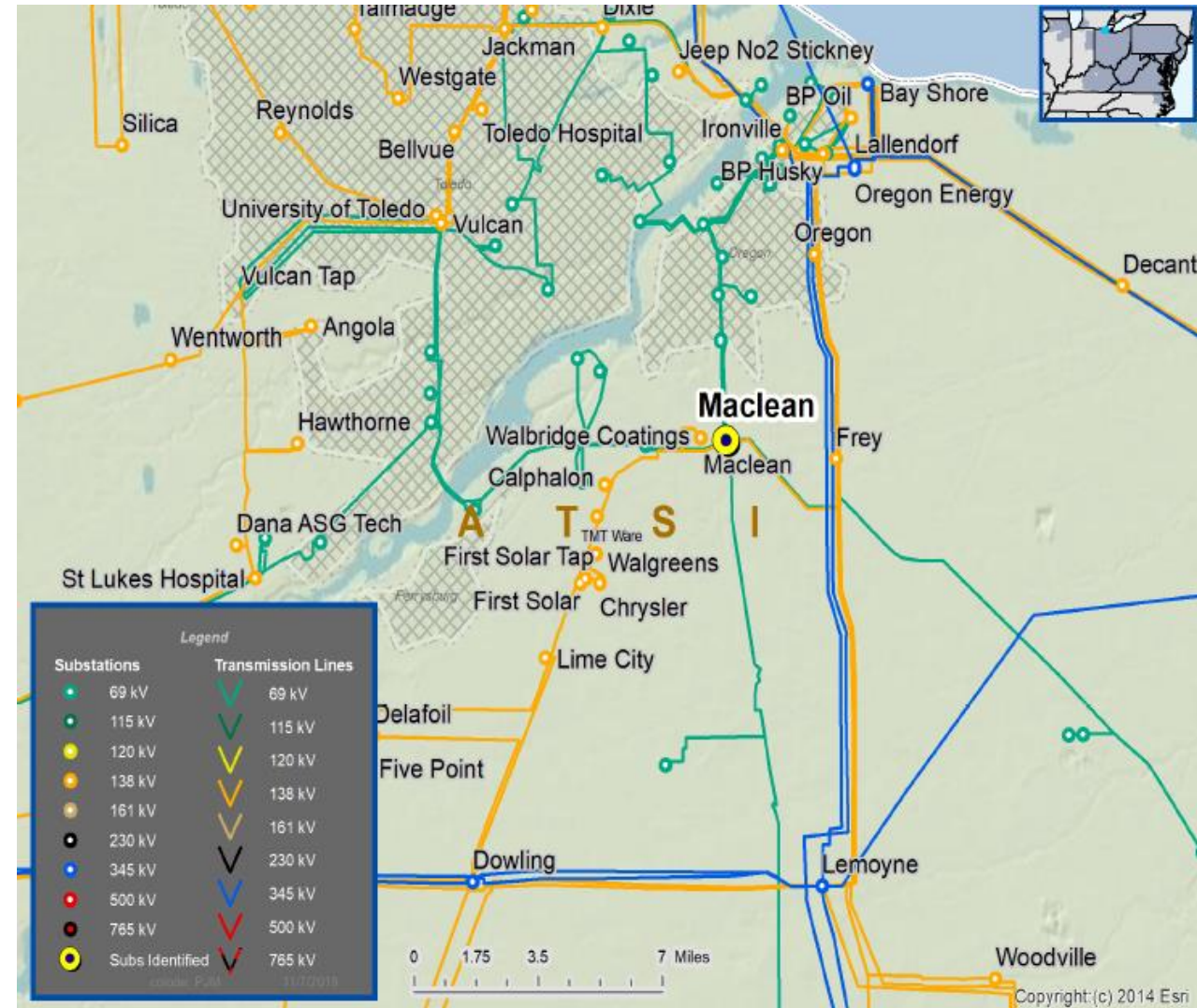



**Need Number:** ATSI-2019-084

**Process Stage:** Submission of Supplemental Project for Inclusion in the Local Plan – 06/08/2020

**Process Stage:** Need Meeting – 11/22/2019  
Solution Meeting – 03/19/2020

### Problem Statement

#### Maclean 138 kV Substation – Breakers and Protection Schemes

- Breakers B13203 and B13204 Oil Circuit Breakers (OCB) are at/beyond expected service life (greater than 30 years) with increasing maintenance concerns; severe hydraulic leaks, oil quality issues, and increasing maintenance trends.
- The electromechanical relays provide limited bus protection with single point of failure.
- The bus PTs are at/beyond expected service life (greater than 40 years).

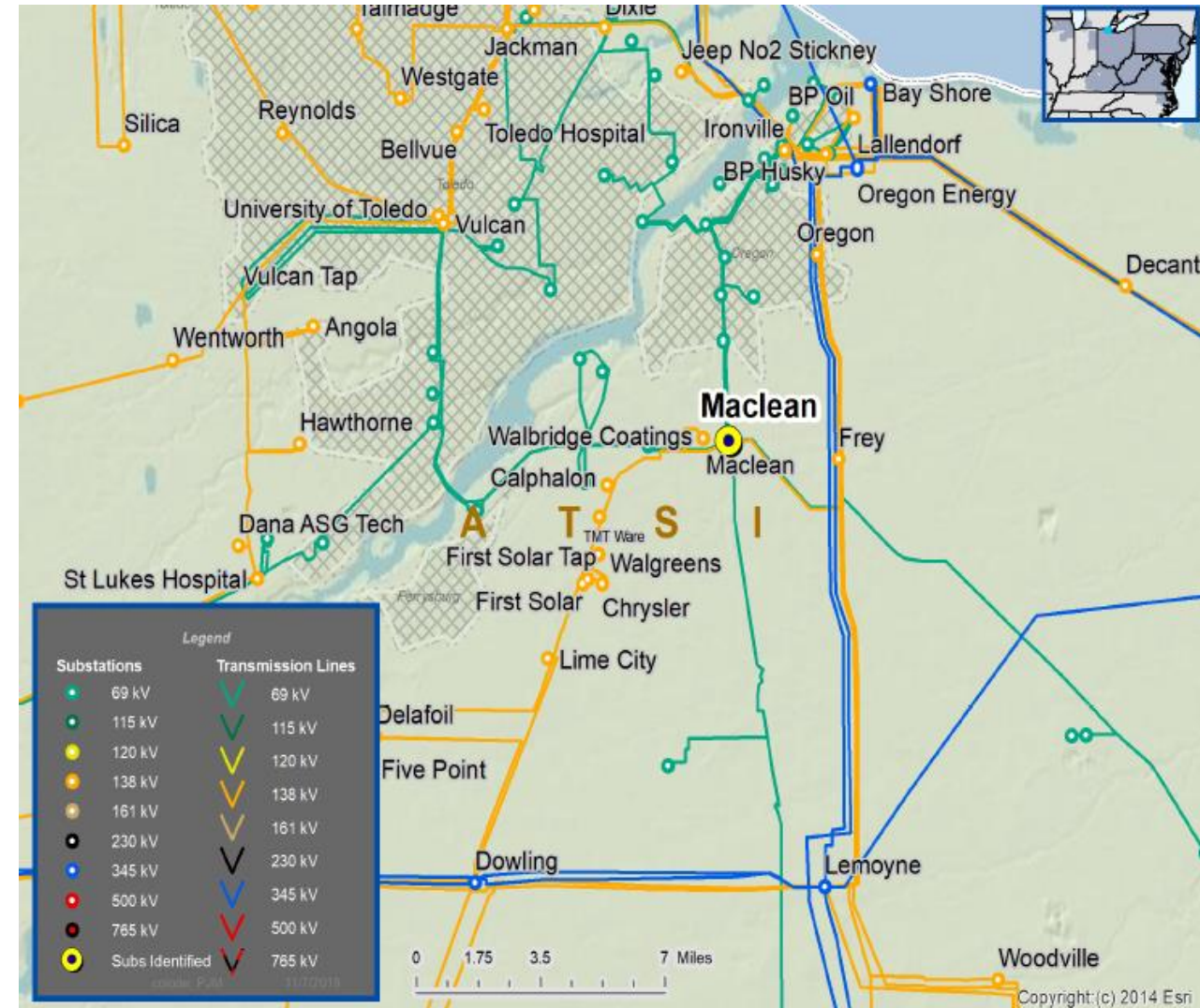



# ATSI Transmission Zone M-3 Process Maclean 138 kV Substation - Solution

**Need Number:** ATSI-2019-084  
**Process Stage:** Submission of Supplemental Project for Inclusion in the Local Plan – 06/08/2020  
**Previously Presented:** Need Meeting – 11/22/2019  
 Solution Meeting – 03/19/2020

**Proposed Solution:**

- Replace 138kV breaker B13204
- Replace 138kV breaker B13203
- Replace disconnect switches for Breaker B13204
- Replace disconnect switches for Breaker B13203
- Replace one (1) disconnect switch for 138-69 kV Transformer No1
- Upgrade substation conductor at Maclean for the Maclean-Chrysler 138 kV Line

**Estimated Project Cost:** \$1.2 M

**Transmission Line Ratings:**

- Maclean-Chrysler 138 kV Line
  - Before Proposed Solution: 327 MVA WN / 394 MVA WE
  - After Proposed Solution: 327 MVA WN / 394 MVA WE
- Maclean-Walbridge Coatings 138 kV Line section of the (Maclean-Chrysler 138 kV Line)
  - Before Proposed Solution: 327 MVA WN / 394 MVA WE
  - After Proposed Solution: 327 MVA WN / 420 MVA WE

**Alternatives Considered:**

- Maintain existing equipment and risk of failure.

**Projected In-Service:** 11/11/2021

**Status:** Conceptual

**Model:** N/A

**No changes in topology;  
No bubble diagram  
required.**

Legend	
500 kV	
345 kV	
138 kV	
69 kV	
34.5 kV	
23 kV	
New	

**Need Number:** ATSI-2019-085  
**Process Stage:** Submission of Supplemental Project for Inclusion in the Local Plan – 06/08/2020  
**Previously Presented:** Need Meeting – 11/22/2019  
 Solution Meeting – 03/19/2020

**Supplemental Project Driver(s):**  
*Equipment Material Condition, Performance and Risk*

**Specific Assumption Reference(s)**

*Global*

- System reliability and performance
- Substation/line equipment limits
- Failure risk, to the extent caused by asset design characteristics, or history industry/company performance data, or application design error
- Expected service life (at or beyond) or obsolescence

*Circuit Breaker and other fault interrupting devices*

- Operating Mechanism

*Switches*

- Blade and jaw assembly
- Operating mechanism

*Station Protection and Control*



- Electromechanical relays

*Devices used for panel, telemetry, and revenue metering*

- Potential Transformers (PTs)

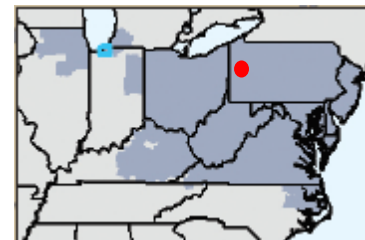
PJM to Provide Map



Legend	
345 kV	
138 kV	
69 kV	

**Need Number:** ATSI-2019-085  
**Process Stage:** Submission of Supplemental Project for Inclusion in the Local Plan – 06/08/2020  
**Previously Presented:** Need Meeting – 11/22/2019  
 Solution Meeting – 03/19/2020

### Problem Statement

Cedar 138/69 kV Street Substation – Breakers, Relays, and Control Building

- Breaker B-26 69 kV Bus Tie Breaker and disconnect switches are at/beyond expected service life (greater than 52 years) with increasing maintenance concerns; deteriorated operating mechanism, spare part availability, and increasing maintenance trends.
- North and South bus PTs are deteriorating and at/beyond expected service life (greater than 40 years).
- Transformer 138/69 kV #1, bus protection, and line exit relays are electromechanical and prone to misoperation.
  - Cedar Street – Shenango 138 kV Line
  - Cedar Street – New Castle 138 kV Line
  - Cedar Street – New Castle #1, #2 and #3 69 kV Lines
  - Cedar Street – Frisco #1 and #2 69 kV Lines
  - Cedar Street – McDowell 69 kV Line
  - Cedar Street – Grant Street 69 kV Line
  - Cedar Street – New Wilmington 69 kV Line
  - Cedar Street – Lowellville North 69 kV Line
  - Cedar Street – Lowellville South 69 kV Line
  - Cedar Street – Columbiana 69 kV Line

### PJM to Provide Map

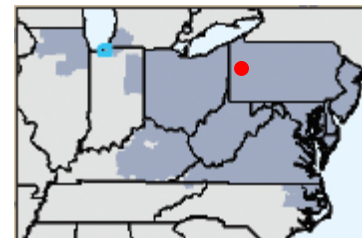

Legend	
345 kV	
138 kV	
69 kV	



**Need Number:** ATSI-2019-086  
**ATSI-2019-091**

**Process Stage:** Submission of Supplemental Project for Inclusion in the Local Plan – 06/08/2020

**Previously Presented:** Need Meeting – 11/22/2019  
 Solution Meeting – 03/19/2020

**Supplemental Project Driver(s):**  
*Equipment Material Condition, Performance and Risk*

**Specific Assumption Reference(s)**

*Global*

- System reliability and performance
- Substation/line equipment limits
- Failure risk, to the extent caused by asset design characteristics, or history industry/company performance data, or application design error
- Expected service life (at or beyond) or obsolescence

*Circuit Breaker and other fault interrupting devices*



- Condition of interrupting media (oil, gas, etc.)

*Station Protection and Control*

- Electromechanical relays

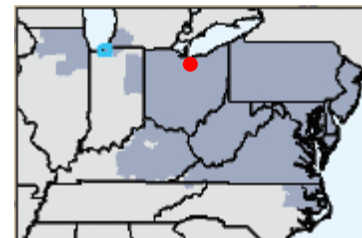
PJM to Provide Map



Legend	
345 kV	
138 kV	
69 kV	

**Need Number:** ATSI-2019-086  
**ATSI-2019-091**

**Process Stage:** Submission of Supplemental Project for Inclusion in the Local Plan – 06/08/2020

**Previously Presented:** Need Meeting – 11/22/2019  
 Solution Meeting – 03/19/2020

**Problem Statement**

**ATSI-2019-086**

**Fowles Breaker Replacement**

- Breaker B-8 Oil Circuit Breaker (OCB) is at/beyond expected service life (greater than 30 years) with increasing Maintenance concerns; Deteriorated bushing potential device and mechanism, Obsolete replacement parts, hot spots, and deteriorated oil within the tank.

**ATSI-2019-091**

**Fowles 138 kV Substation – Breaker and substation equipment**

- Breaker B-2 Oil Circuit Breaker (OCB) is at/beyond expected service life (greater than 30 years) with increasing maintenance concerns; hot spots, oil leaks, and increasing maintenance trends.
- CTs and disconnect switches are at/beyond expected service life.
- Relays are electromechanical and prone to misoperation.

**Pleasant Valley 138 kV Substation – Breakers and Substation Equipment**

- Breaker B-1 Oil Circuit Breaker (OCB) is at/beyond expected service life (greater than 30 years) with increasing maintenance concerns; hot spots and deteriorated oil within the tank, deterioration of terminal block wiring in the cabinet.
- CTs and disconnect switches are at/beyond expected service life.

**PJM to Provide Map**

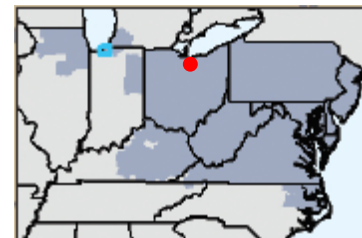

Legend	
345 kV	
138 kV	
69 kV	

**Need Number:** ATSI-2019-087  
**Process Stage:** Submission of Supplemental Project for Inclusion in the Local Plan – 06/08/2020  
**Previously Presented:** Need Meeting – 11/22/2019  
 Solutions Meeting – 03/19/2020

**Supplemental Project Driver(s):**  
 Equipment Material Condition, Performance and Risk

**Specific Assumption Reference(s)**

Global

- System reliability and performance
- Substation/line equipment limits
- Expected service life (at or beyond) or obsolescence

Switches

- Stick-operated line and/or bus switch – Blade and jaw assembly.

Station System Protection and Control

- Electro-mechanical relays – Capability

Upgrade Relay Schemes

- Relay schemes that have a history of misoperation

**Problem Statement**

Cloverdale Substation – Breakers and Relays

- The transformer 138/69 kV relaying is electro-mechanical and is prone to misoperation. The substation disconnects ~~D264~~, ~~D262~~, ~~D265~~, D195, D194, D193 and D192 have deteriorating blades and jaws.
- Transformer Breaker B-191 Oil Circuit Breaker (OCB) is aging greater than 30 years with increasing replacement concerns.

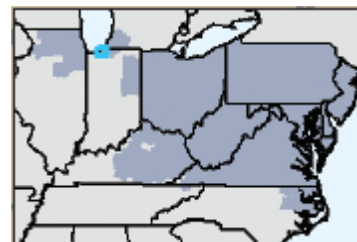
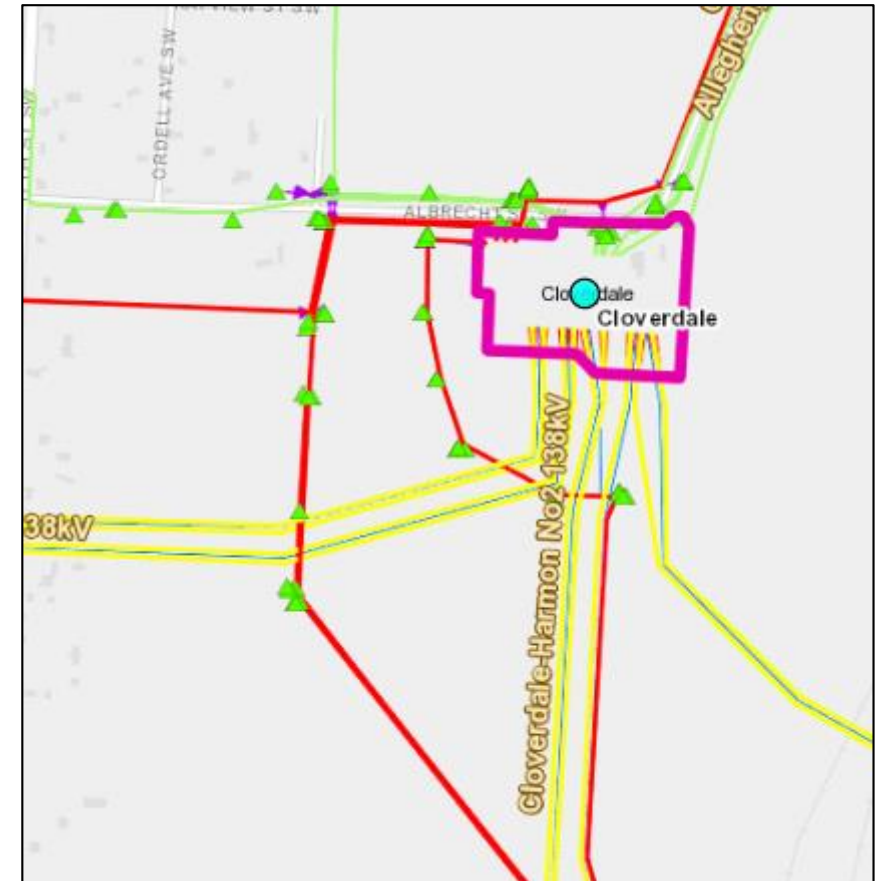

Legend	
345 kV	
138 kV	
69 kV	

**Need Number:** ATSI-2019-087  
**Process Stage:** Submission of Supplemental Project for Inclusion in the Local Plan – 06/08/2020  
**Previously Presented:** Need Meeting – 11/22/2019  
 Solutions Meeting – 03/19/2020

**Proposed Solution:**

- Upgrade (5) 138kV disconnect switches (D192, D193, D194, D195, D265) with 138kV, 1200A DSWs
- Replace existing transformer No. 4 relaying with two (2) standard transformer relaying panels.
- Modify existing SCADA RTU for new relaying
- Replace breaker B-191

**Estimated Project Cost:** \$2.2 M

**Transmission Line Ratings:**

- Cloverdale TR4 rating:
  - Before Proposed Solution: 143/143 MVA
  - After Proposed Solution: 159/159 MVA

**Alternatives Considered:**

- Maintain existing condition and elevated risk of failure

**Projected In-Service:** 10/15/2020

**Project Status:** Conceptual

**Model:** N/A

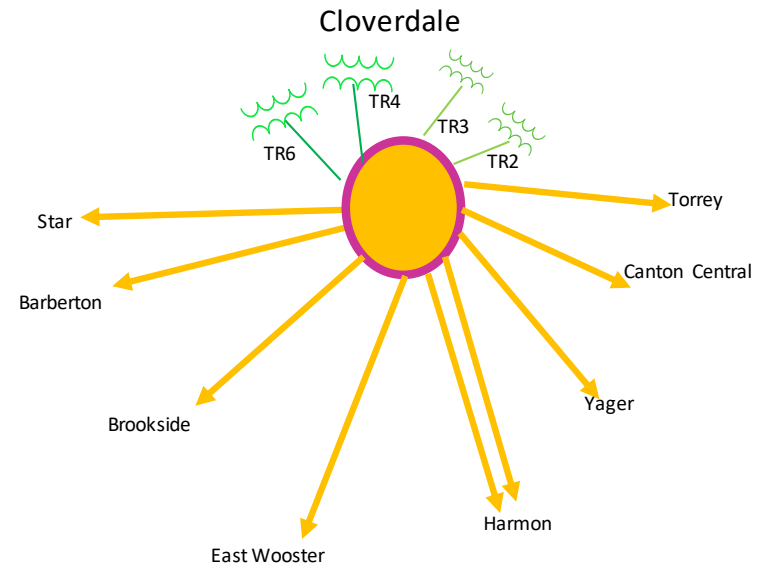

Legend	
500 kV	
345 kV	
138 kV	
69 kV	
34.5 kV	
23 kV	
New	

**Need Number:** ATSI-2019-088  
**Process Stage:** Submission of Supplemental Project for Inclusion in the Local Plan – 06/08/2020  
**Previously Presented:** Need Meeting – 11/22/2019  
 Solution Meeting – 03/19/2020

**Supplemental Project Driver(s):**  
*Equipment Material Condition, Performance and Risk*

**Specific Assumption Reference(s)**

*Global*

- System reliability and performance
- Load and/or Customer at risk on single transmission line.
- Increasing negative trend in maintenance findings and/or costs
- Failure risk, to the extent caused by asset design characteristics, or history industry/company performance data, or application design error
- Expected service life (at or beyond) or obsolescence

*Automatic Sectionalizing Schemes*

- Evaluate load at risk and/or customers impacted

*Circuit Breaker and other fault interrupting devices*

- Condition of interrupting media (oil, gas, etc.)
- Operating mechanism

*Upgrade Relay Schemes*

- Bus protection schemes which rely on remote clearing
- Protection system with single point of failure
- Relay schemes that have a history of misoperation

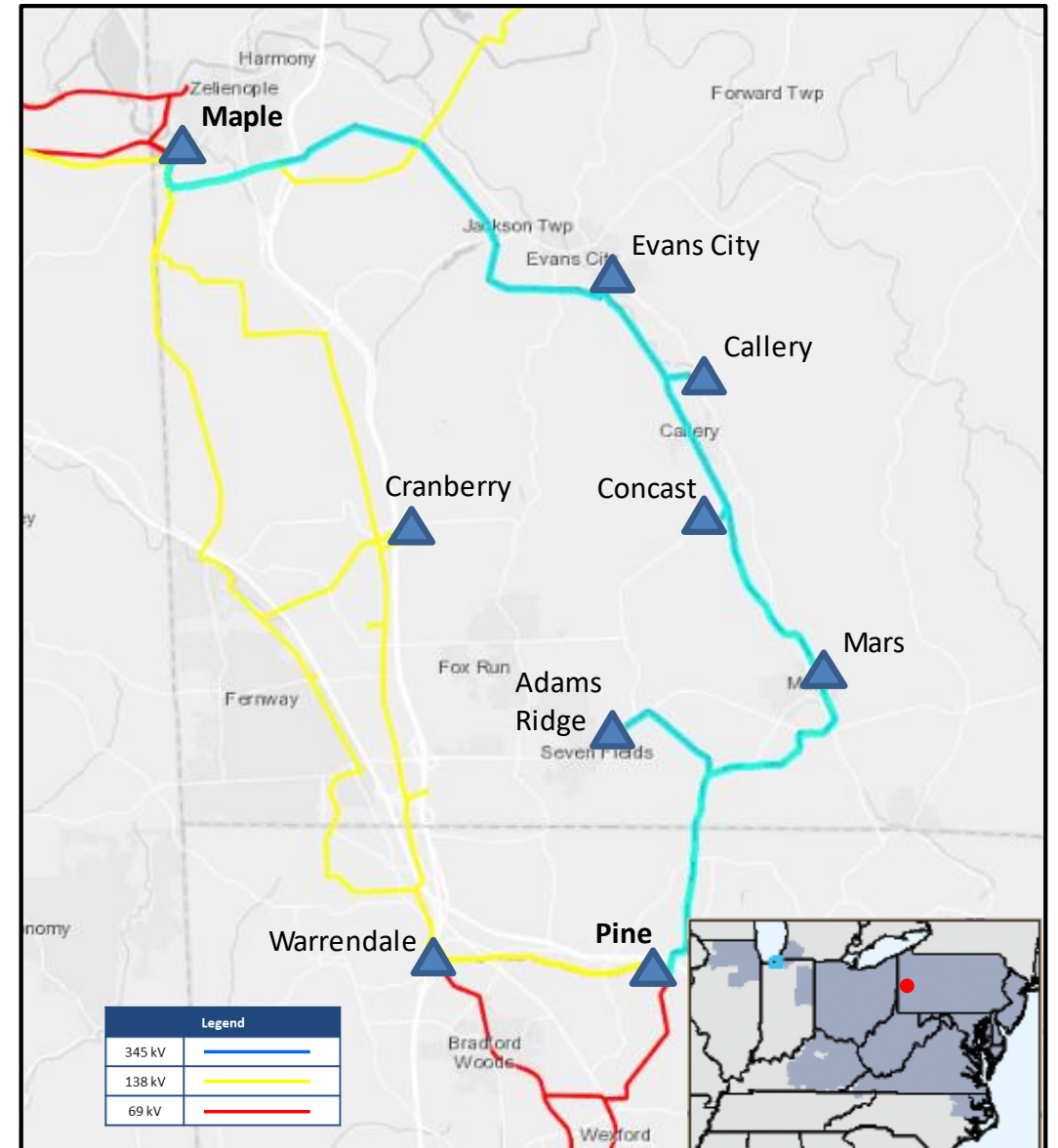

**Need Number:** ATSI-2019-088  
**Process Stage:** Submission of Supplemental Project for Inclusion in the Local Plan – 06/08/2020  
**Previously Presented:** Need Meeting – 11/22/2019  
 Solution Meeting – 03/19/2020

### Problem Statement

#### Maple-Pine 69 kV Line

- The existing 69 kV transmission line is approximately 18 miles long with approximately 45 MWs of load and 11,500 customers at risk. The largest customer and load base at risk is located at Mars substation (22 MWs / 5,300 Customers).
- Overall line condition is adequate based on recent line inspection results.
- System performance over the past five years: 5 momentary / 6 sustained

#### Pine 69 kV Substation – Breakers and Protection Schemes

- Several SF6 breakers at Pine substation at/beyond expected service life with increasing maintenance concerns;
  - Breaker B-18 has history of SF6 leaks
  - Breaker B-14 has history of SF6 leaks and has had air tank issues
  - Breaker B-22 has experienced a bushing failure and repairs
  - Breaker B-26 has had a bushing, air receiver, pilot valve and a lower pressure cut-off valve issues
- The transfer line and bus protection electro-mechanical relays are prone to mis-operate due to components failing without warning.

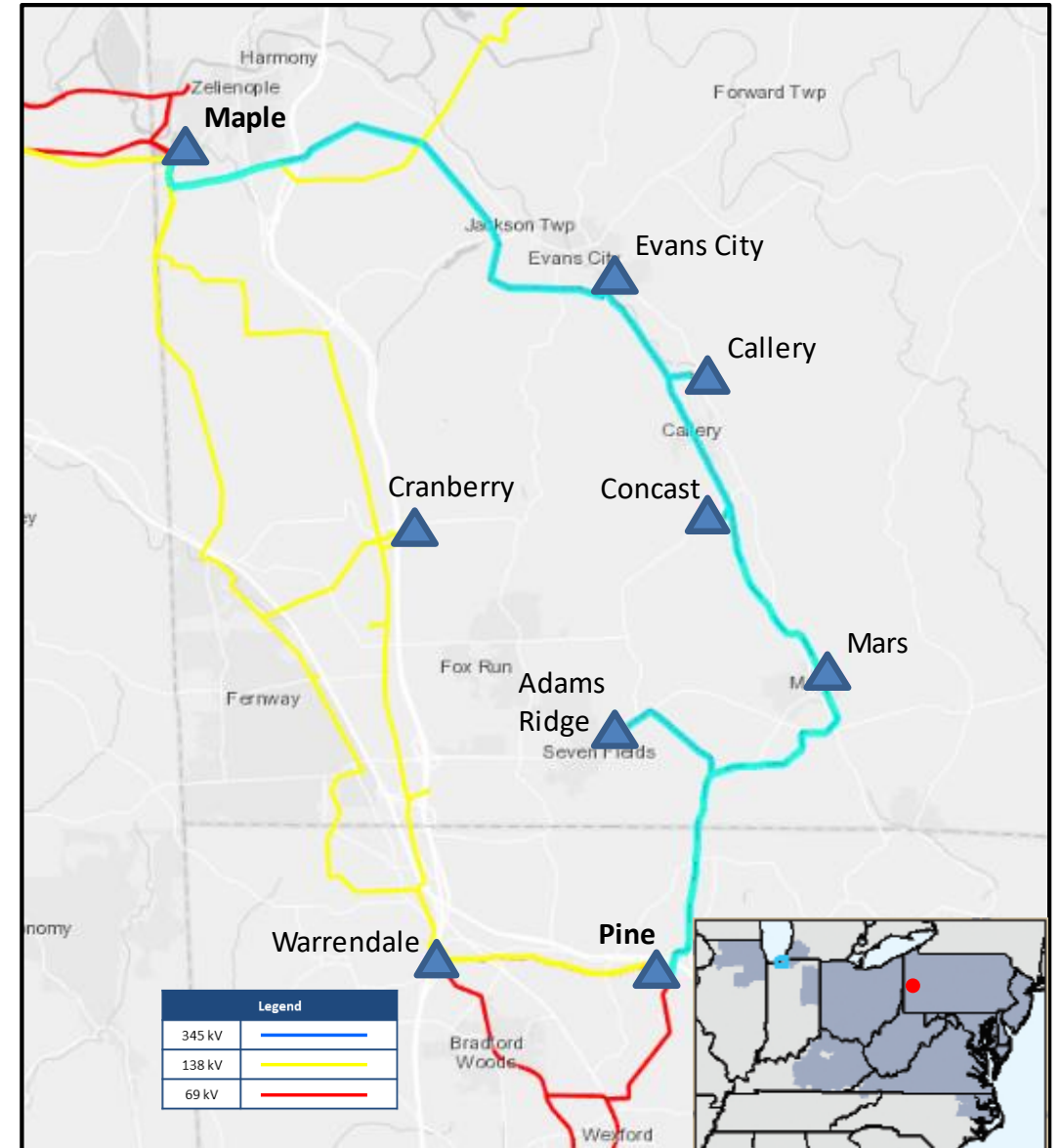



# ATSI Transmission Zone M-3 Process

## Install Auto-Sectionalizing Scheme by Expanding Mars Substation - Solution

**Need Number:** ATSI-2019-088  
**Process Stage:** Submission of Supplemental Project for Inclusion in the Local Plan – 06/08/2020  
**Previously Presented:** Need Meeting – 11/22/2019  
 Solution Meeting – 03/19/2020

**Proposed Solution:**

- Expand Mars substation
- Install two 69 kV MOAB switches
- Replace the 69 kV Y-192 (B130) reclosing relay and adjust settings at Maple
- Replace the 69 kV Y-192 (B14) reclosing relay and adjust settings at Pine
- Replace 69 kV breakers B14, B18, B22, & B26 at Pine
- Replace 69 kV breaker B130 at Maple
- Upgrade substation conductor at Pine

**Estimated Project Cost:** \$3.5 M

**Transmission Line Ratings:**

- Pine-Adams Ridge 69 kV Line Segment
  - Before Proposed Solution: 133 MVA SN / 150 MVA SE
  - After Proposed Solution: 141 MVA SN / 171 MVA SE
- Pine-Wexford Tap 69 kV Line Segment
  - Before Proposed Solution: 133 MVA SN / 169 MVA SE
  - After Proposed Solution: 139 MVA SN / 169 MVA SE

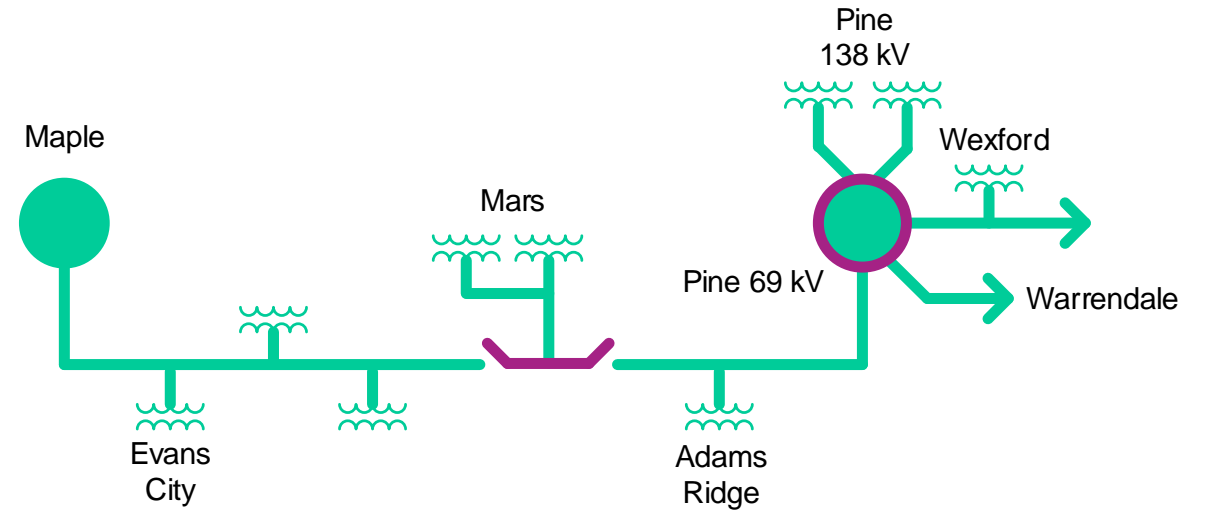

**Alternatives Considered:**

- Maintain existing configuration (SCADA)
- Mars 69 kV ring bus (space constraint)

**Projected In-Service:** 12/31/2020  
**Status:** Engineering  
**Model:** 2019 Series 2024 Summer RTEP 50/50

Legend	
500 kV	
345 kV	
138 kV	
69 kV	
34.5 kV	
23 kV	
New	

# ATSI Transmission Zone

**Need Number:** ATSI-2019-015  
**Process Stage:** Submission of Supplemental Project for Inclusion in the Local Plan – 07/02/2020  
**Previously Presented:** Solutions Meeting – 03/25/2019  
Needs Meeting – 01/14/2019

**Project Driver(s):**  
*Equipment Material, Condition, Performance and Risk*

## Specific Assumption Reference(s)

### Global Factors

- At or beyond expected service life or obsolete
- Failure risk, to the extent caused by asset design characteristics, or historical industry/company performance data, or application design error
- Show a high level of criticality to system performance and operations

### Substation Condition Rebuild/ Replacement

- Circuit breakers and other fault interrupting devices
- Switches
- Station system protection and controls

## Problem Statement

### Ashtabula 138 kV Substation Equipment and Protection

- *Two (2) 138 kV breakers (B143 & B149), lightning arresters and associated switches, and control wiring are showing degrading performance, increasing maintenance, age (46-63 years), and obsolescence of equipment and spare parts.*





# ATSI Transmission Zone

**Need Number:** ATSI-2019-015  
**Process Stage:** Submission of Supplemental Project for  
Inclusion in the Local Plan – 07/02/2020  
**Previously Presented:** Solutions Meeting – 03/25/2019  
Needs Meeting – 01/14/2019

**Proposed Solution (S2259):**

*Ashtabula 138 kV Breakers and Relay Upgrades*

- Replace two (2) 138 kV breakers (B143 & B149), associated switches, and substation conductor.

**Transmission Line Ratings:**

- Ashtabula-Pitts Conn Dock Q15 138 kV Line
  - Before Proposed Solution: 329 MVA SN / 399 MVA SE
  - After Proposed Solution: 347 MVA SN / 423 MVA SE

**Alternatives Considered:**

- Maintain existing condition and risk of failure.

**Estimated Project Cost:** \$5.2M

**Projected IS Date:** 12/31/2019

**Status:** Conceptual

No diagram required.  
All work is within the substation

**Need Number:** ATSI-2019-016  
**Process Stage:** Submission of Supplemental Project for Inclusion in the Local Plan – 07/02/2020  
**Previously Presented:** Needs Meeting – 01/11/2019  
 Solutions Meeting – 04/20/2020

**Project Driver(s):**  
*Equipment Material, Condition, Performance and Risk*

**Specific Assumption Reference(s):**

**Global Factors**

- At or beyond expected service life or obsolete
- Failure risk, to the extent caused by asset design characteristics, or historical industry/company performance data, or application design error
- Show a high level of criticality to system performance and operations

**Substation Condition Rebuild / Replacement**

- Circuit breakers and other fault interrupting devices
- Switches
- Risers and connections

**Problem Statement:**

Chamberlin 138 kV Substation

- Two (2) 138 kV Oil Circuit Breaker (OCB) breakers (B86 & B69) and MOAB Switch A-19 at Chamberlin are showing degrading performance, increasing maintenance, age (> 30 years), and obsolescence of equipment and spare parts.

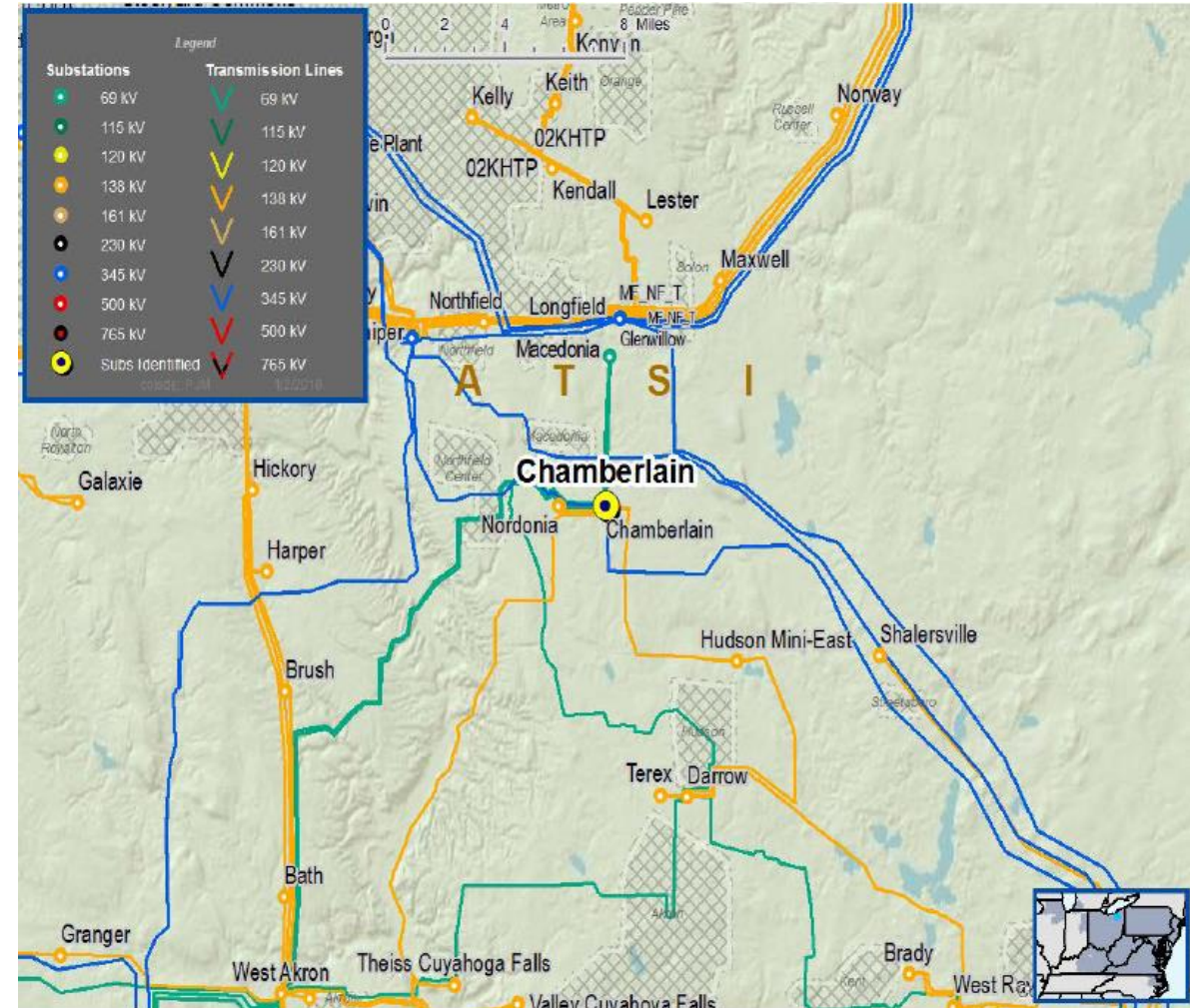



## ATSI Transmission Zone M-3 Process Chamberlin 138 kV Substation - Solution

**Need Number:** ATSI-2019-016  
**Process Stage:** Submission of Supplemental Project for  
Inclusion in the Local Plan – 07/02/2020  
**Previously Presented:** Needs Meeting – 01/11/2019  
Solutions Meeting – 04/20/2020

### **Proposed Solution(S2245):**

Chamberlin 138 kV Breaker and Switch Upgrades

- Replace two (2) 138 kV Oil Circuit Breaker (OCB) breakers ( ) B86 & B69 that are part of the protection scheme for the two 138 / 69 kV transformers at Chamberlin substation, upgrade the transformer #2 relay, and replace MOAB Switch A-19.

### **Transmission Line Ratings:**

- Chamberlin 138 / 69 kV Transformer #2
  - Before Proposed Solution: 163 MVA SN/ 163 MVA SE
  - After Proposed Solution: 164 MVA SN/ 174 MVA SE

### **Alternatives Considered:**

- Maintain existing condition and risk of failure.

**Estimated Project Cost:** \$0.5M

**Projected IS Date:** 03/31/2021

**Status:** Engineering

No diagram required.  
All work is within the substation

**Need Number:** ATSI-2019-050  
**Process Stage:** Submission of Supplemental Project for  
Inclusion in the Local Plan – 07/02/2020  
**Previously Presented:** Solutions Meeting – 03/07/2019  
Needs Meeting – 02/07/2019

**Project Driver(s):**

*Equipment Material, Condition, Performance and Risk  
Operational Flexibility and Efficiency  
Infrastructure Resilience*

**Specific Assumption Reference(s)**

**Global Factors**

- System reliability and performance
- Load at risk in planning and operational scenarios

**Reconductor / Rebuild Transmission Lines**

- Three or more terminal transmission lines

**Upgrade Relay Schemes**

- Relay schemes that have a history of misoperation
- Obsolete and difficult to repair communication equipment

*Continued on next slide...*

# ATSI Transmission Zone

**Need Number:** ATSI-2019-050  
**Process Stage:** Submission of Supplemental Project for Inclusion in the Local Plan – 07/02/2020  
**Previously Presented:** Solutions Meeting – 03/07/2019  
Needs Meeting – 02/07/2019

...Continued from previous slide.

## Problem Statement

### Perry-Ashtabula-Erie West 345 kV Line and Surrounding Areas

- Perry-Ashtabula-Erie West 345 kV Line is a three terminal line.
  - Three terminal lines are prone to mis-operations, lengthy fault locating analysis and longer restoration efforts.
  - Existing transmission relay communication equipment is approaching end of life, is obsolete, and is difficult to maintain and repair.
  - Non-planning criteria violation voltage concerns on the > 100 kV system under contingency conditions.
    - Loss of the Perry-Ashtabula-Erie West 345 kV (FE-P1-2-CEI-345-700T), or the Ashtabula 345/138kV TR (FE-P1-3-SYS-345-722), followed by the loss of Leroy Center-Stacy Q3 138 kV line (FE-P1-2-CEI-138-087).
- OR**
- Loss of Leroy Center-Ashtabula Q4 138 kV line followed by the loss of the Leroy Center-Stacy Q3 138 kV line (FE-P7-1-CEI-138-058)

Results in low voltage (< 88 %), large voltage drop (11.3%), and/or potential local voltage collapse at Stacy substation; load shed of approximately 75 MWs is necessary to maintain system voltages.

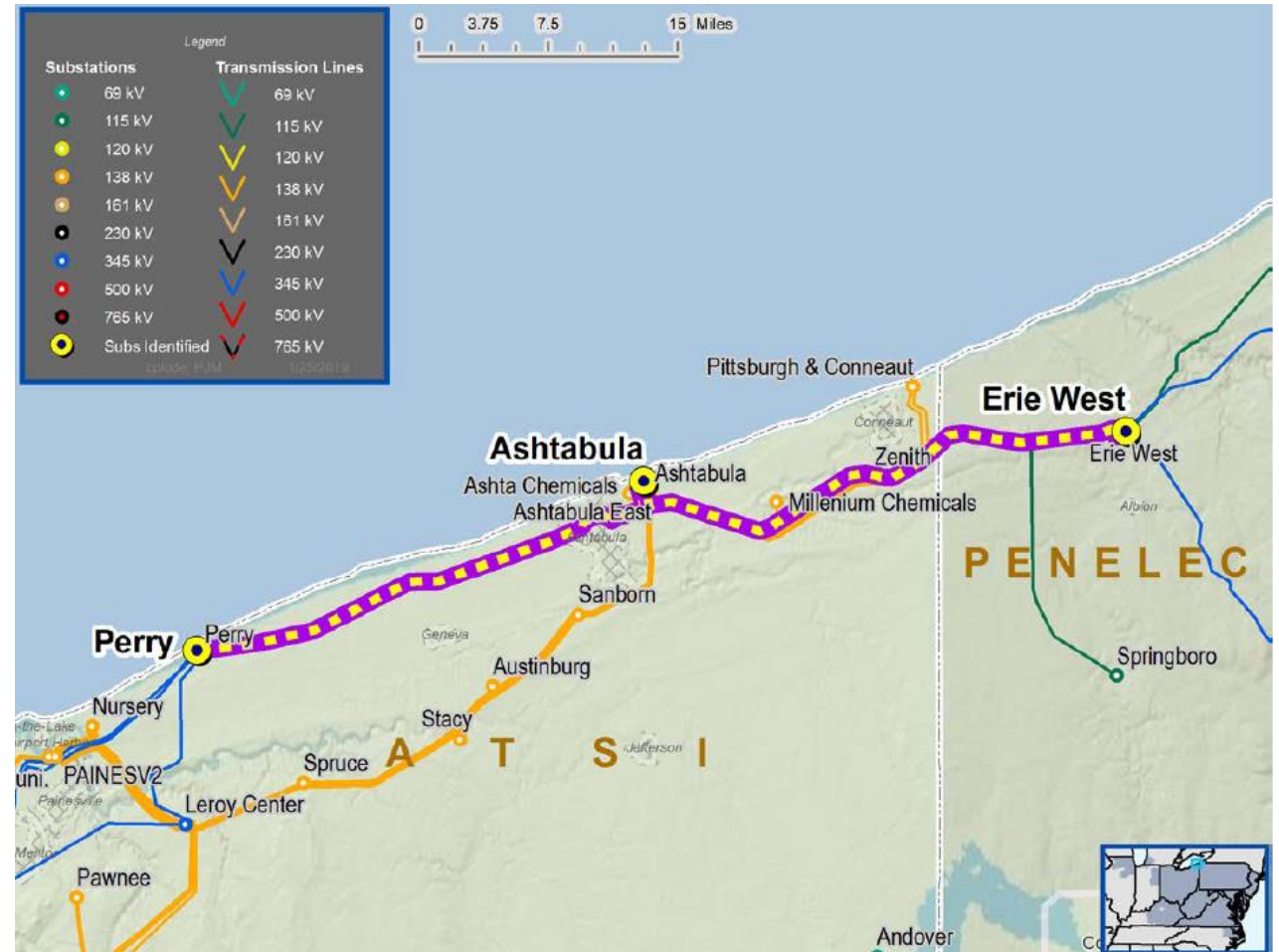

# ATSI Transmission Zone

**Need Number:** ATSI-2019-050  
**Process Stage:** Submission of Supplemental Project for Inclusion in the Local Plan – 07/02/2020  
**Previously Presented:** Solutions Meeting – 03/07/2019  
Needs Meeting – 02/07/2019

Continued from previous slide...

**Potential Solution(\$2260):**

***Perry-Ashtabula-Erie West 345 kV Three-Terminal Line Elimination Project***

- Rebuild 1.5 miles of the Perry-Ashtabula-Erie West 345 kV tap line as double circuit, match existing tap conductor.
  
- Reconfigure the existing Ashtabula tap location to create:
  - Erie West – Ashtabula 345 kV line (1560 MVA SN / 1900 MVA SE)
  - Ashtabula – Perry 345 kV line (1560 MVA SN / 1900 MVA SE)
  
- Expand the existing 345 kV substation at Ashtabula to a six (6) breaker ring bus
- Add a second 345/138 kV 448 MVA transformer between the new 345 kV ring bus and the existing 138 kV bus at Ashtabula.
- Add a new 138 kV circuit breaker to terminate the new transformer to the 138 kV bus.

**Alternatives Considered:** Maintain existing configuration.

**Estimated Project Cost:** \$23.7M

**Projected IS Date:** 12/31/2020

**Status:** Conceptual

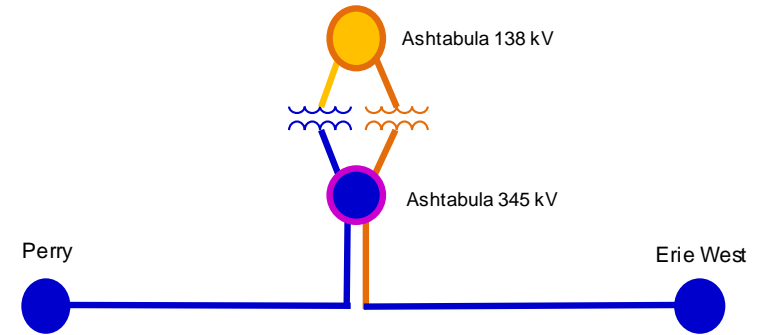

Legend	
500 kV	
345 kV	
138 kV	
69 kV	
34.5 kV	
23 kV	
New	





# ATSI Transmission Zone M-3 Process Richland-East Leipsic 138 kV Line - Solution

**Need Number:** ATSI-2020-002  
**Process Stage:** Submission of Supplemental Project for Inclusion in the Local Plan – 07/02/2020  
**Previously Presented:** Needs Meeting – 02/21/2020  
Solutions Meeting – 04/20/2020

**Supplemental Project Driver(s):**  
*Equipment Material Condition, Performance and Risk*

## **Specific Assumption Reference(s):**

### **Line Condition Rebuild / Replacement**

- Aged or deteriorated wood pole transmission line structures
- Negatively impact customer outage frequency and/or durations
- Demonstrate an increasing trend in maintenance findings and/or costs
- Transmission line ratings are limited by terminal equipment.

## **Problem Statement:**

Richland-East Leipsic 138 kV (~15.8 miles) Transmission Line:

- The Richland-East Leipsic 138 kV Transmission Line was built in the 1960s. The average age of the structures on this line are 54 years old. FirstEnergy has historically experienced an average age of reject for wood poles to be 48.7 years.
- Line was surveyed in 2018 and showed a structure reject rate of 100% (126/126). The primary reasons for reject were structure age, woodpecker holes, pole top decay, and phase raised structures.
- There has been a growing trend in unscheduled interruptions on this line. There have been 11 total outages since 2011 for lightning, equipment failures, and other issues.
- There has been an increase in unplanned maintenance on this line. A recent aerial patrol found 90 active maintenance conditions requiring repair for wood pole rot, broken static wire and attachment hardware, and bent braces.

**Need Number:** ATSI-2020-002  
**Process Stage:** Submission of Supplemental Project for Inclusion in the Local Plan – 07/02/2020  
**Previously Presented:** Needs Meeting – 02/21/2020  
 Solutions Meeting – 04/20/2020

**Proposed Solution(S2246):**

**Richland-East Leipsic 138 kV Line Rebuild**

- Rebuild entire 15.8 mile of the ATSI owned Richland-East Leipsic 138 kV line.
- Replace existing conductor (636 kcmil ACSR) with 795 kcmil ACSR.
- Install OPGW along the entire line.

**Upgrade Richland Line Terminal**

- Substation equipment for replacement includes: Breaker B13250, disconnect switches, line trap, CVT, tuner and COAX, substation conductor, relaying, and revenue metering.
- Existing line rating: 223 SN / 223 SE  
257 WN / 270 WE
- New line rating: 223 SN / 223 SE (Line rating limited by neighboring TO)  
281 WN / 281 WE (Line rating limited by neighboring TO)

**Alternatives Considered:**

- Maintain existing condition and elevated risk of failure and increasing maintenance costs

**Estimated Project Cost:** \$16.9 M  
**Projected IS Date:** 12/31/2021  
**Status:** Preliminary Engineering

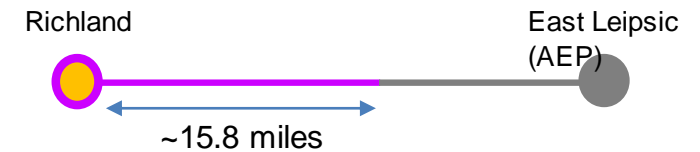

Legend	
500 kV	
345 kV	
138 kV	
69 kV	
34.5 kV	
23 kV	
New	
Owned by Neighboring TO	



**Need Number:** ATSI-2020-006 (s2261)  
**Process Stage:** Submission of Supplemental Project for Inclusion in the Local Plan – 09/25/2020  
**Previously Presented:** Need Meeting – 04/20/2020  
Solution Meeting – 05/22/2020

**Project Driver:**

*Equipment Material Condition, Performance and Risk  
Operational Flexibility and Efficiency  
Infrastructure Resilience*

**Specific Assumption References:**

*Global Factors*

- System reliability and performance
- Substation / line equipment limits

**Problem Statement**

Abbe – Johnson #1 69 kV switch (A-47)

- Switch originally installed in 1982
- Corrosion on operating mechanism
- Existing KPF switch is obsolete and no longer supported by the manufacturer
- Undesirable design with vertical operating rod
- Transmission line ratings are limited by the existing switch rating



Continued on next slide...

...Continued from previous slide

ATSI-2020	Transmission Line / Substation Locations	Existing Line/Terminal Equipment MVA Rating (SN / SE)	Existing Conductor/Transformer MVA Rating (SN / SE)	Limiting Terminal Equipment
-006	Abbe-Johnson #1 69 kV Line switch A-47	82 / 103	110/134	Switch A-47



# ATSI Transmission Zone M-3 Process Abbe-Johnson # 1 69 kV Switch Solution

**Need Number:** ATSI-2020-006 (s2261)  
**Process Stage:** Submission of Supplemental Project for Inclusion in the Local Plan – 09/25/2020  
**Previously Presented:** Need Meeting – 04/20/2020  
Solution Meeting – 05/22/2020

## Proposed Solution:

Abbe – Johnson #1 69 kV switch (A-47)

- Replace switch A-47 on the Abbe – Johnson #1 69 kV Line with a 1200 A quick break switch with whip

## Transmission Line Ratings:

- Abbe – Johnson #1 69 kV Line
  - Before Proposed Solution: 82 MVA SN/ 103 MVA SE
  - After Proposed Solution: 110 MVA SN/ 134 MVA SE

## Alternatives Considered:

- Maintain existing condition and risk of failure.

**Estimated Project Cost:** \$0.32M

**Projected IS Date:** 06/29/2020

**Status:** Engineering

**No changes in topology;  
No bubble diagram required.**

**Need Number:** ATSI-2019-068 (s2262)  
**Process Stage:** Submission of Supplemental Project for Inclusion in the Local Plan – 09/25/2020  
**Previously Presented:** Need Meeting – 07/24/2019  
 Solution Meeting – 05/22/2020

**Project Driver:**  
*Operational Flexibility and Efficiency*  
*Equipment Material Condition, Performance and Risk*  
*Infrastructure Resilience*

**Specific Assumption References:**

*Global Factors*

- System reliability and performance
- Substation / line equipment limits
- Load at risk in planning and operational scenarios

*Substation Condition Rebuild/Replacement*

- Circuit breakers and other fault interrupting devices

*Add/Expand Bus Configuration*

- Loss of substation bus adversely impacts transmission system performance.
- Eliminate simultaneous outages to multiple networked elements
- Capability to perform system maintenance

*Upgrade Relay Schemes*

- Bus protection schemes
- Relay schemes that have a history of misoperation

Continued on next slide...

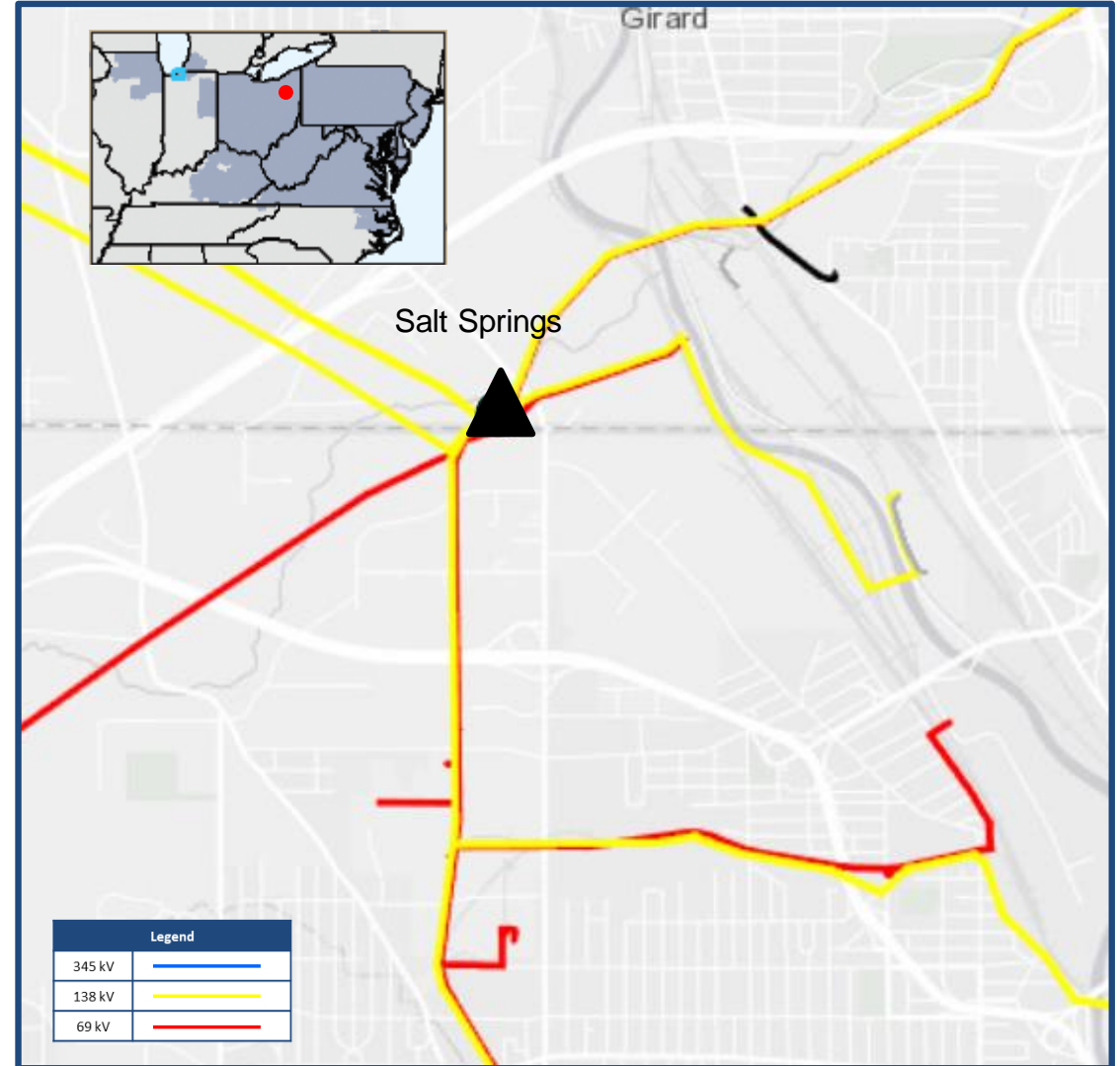

**Need Number:** ATSI-2019-068 (s2262)  
**Process Stage:** Submission of Supplemental Project for Inclusion in the Local Plan – 09/25/2020  
**Previously Presented:** Need Meeting – 07/24/2019  
 Solution Meeting – 05/22/2020

**Problem Statement (continued)**

**Salt Springs 138 kV Substation**

- System analysis shows that after a Salt Springs 138 kV Bus Fault a substantial amount of load is at risk (roughly 133 MW).
- Bus blocking scheme in place is complicated and requires multiple relays to all function properly for every internal and external fault.
- The 138 kV breakers B35, B56, B40, B2, B42, B45 do not have enough CTs for separate inputs to a primary and backup differential scheme.
- Relays on the Salt Springs-Riverbend 138 kV Line and the relays on the Salt Springs-Masury 138 kV Line have a history of misoperation.
- Breakers B35 and B45 are oil circuit breakers over 45 years old

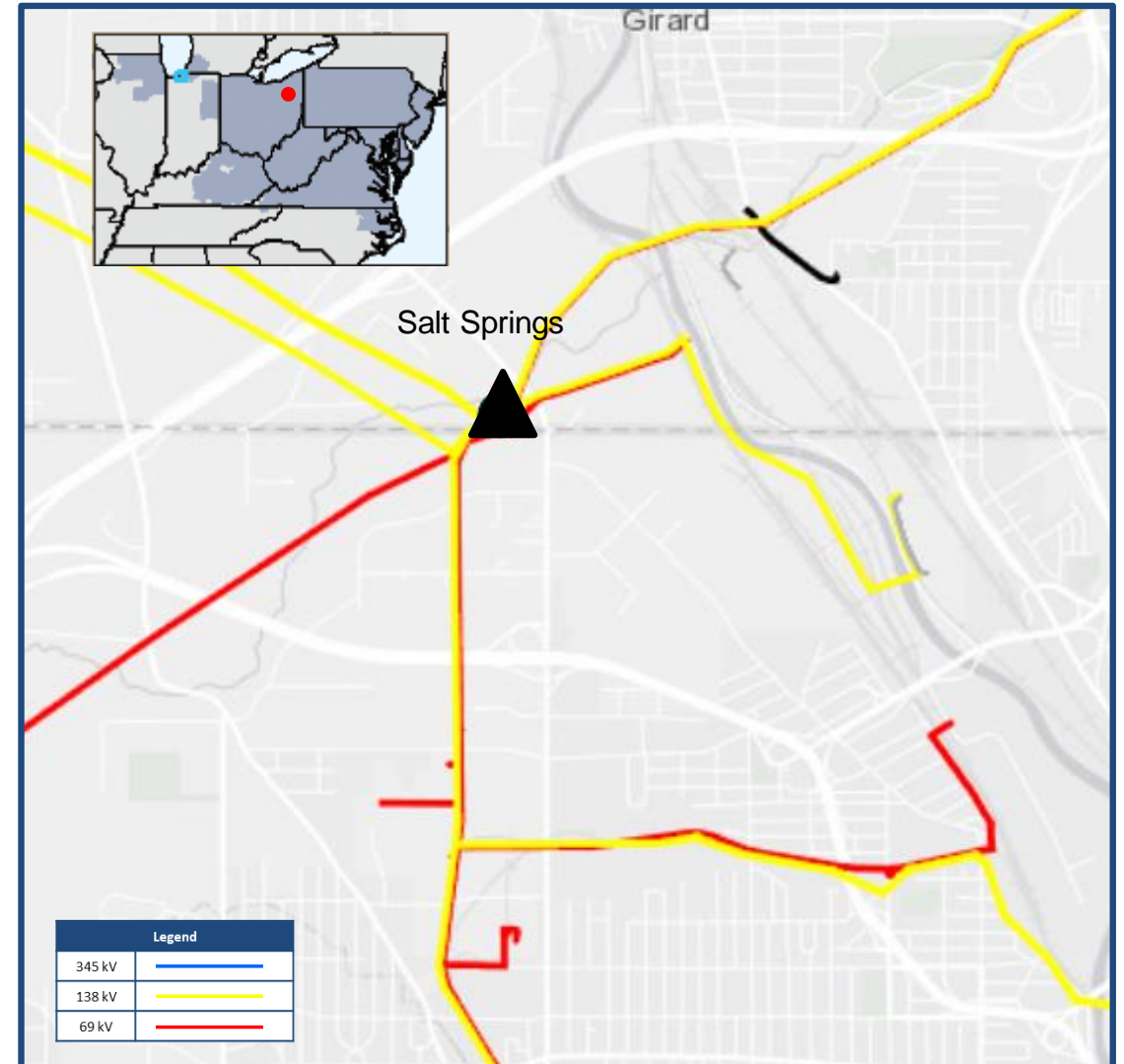

# ATSI Transmission Zone M-3 Process Salt Springs 138 kV Substation Solution

**Need Number:** ATSI-2019-068 (s2262)  
**Process Stage:** Submission of Supplemental Project for Inclusion in the Local Plan – 09/25/2020  
**Previously Presented:** Need Meeting – 07/24/2019  
 Solution Meeting – 05/22/2020

**Proposed Solution:**

**Salt Springs Breaker and a Half**

- Convert Salt Springs to a breaker-and-a-half substation by installing ten 138 kV breakers (replacing six existing 138 kV breakers: B35, B2, B42, B45, B56, B40)
- Install new control building
- Expand substation to allow for conversion of Salt Springs to a breaker-and-a-half
- Install new relays and CVT's
- Upgrade substation conductor at Masury, Niles, and Salt Springs

**Transmission Line Ratings:**

- **Masury-Salt Springs 138 kV Line**
  - Before Proposed Solution: 128 MVA SN / 165 MVA SE
  - After Proposed Solution: 185 MVA SN / 189 MVA SE
- **Niles-Salt Springs #1 138 kV Line**
  - Before Proposed Solution: 240 MVA SN / 310 MVA SE
  - After Proposed Solution: 278 MVA SN / 339 MVA SE
- **Niles-Salt Springs #2 138 kV Line**
  - Before Proposed Solution: 225 MVA SN / 295 MVA SE
  - After Proposed Solution: 278 MVA SN / 339 MVA SE

**Alternative Considered:**

- Maintain existing system configuration
- Build additional 138 kV feed for V&M Star Steel from Riverbend (2.5 miles) and constructing a three-breaker ring bus near V&M Star Steel

**Estimated Project Cost:** \$19.6M

**Projected In-Service:** 6/1/2024

**Status:** Conceptual

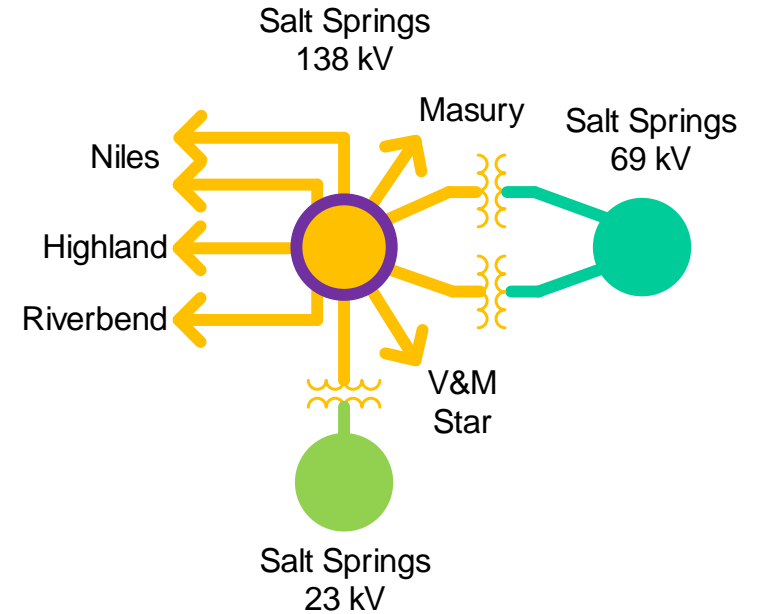

Legend	
500 kV	
345 kV	
138 kV	
69 kV	
34.5 kV	
23 kV	
New	

**Need Number:** ATSI-2019-069 (s2263)  
**Process Stage:** Submission of Supplemental Project for Inclusion in the Local Plan – 09/25/2020  
**Previously Presented:** Need Meeting – 07/24/2019  
 Solution Meeting – 05/22/2020

**Project Driver:**  
*Equipment Material Condition, Performance and Risk*  
*Operational Flexibility and Efficiency*  
*Infrastructure Resilience*

**Specific Assumption References:**

*Global Factors*

- System reliability and performance
- Substation / line equipment limits
- Increasing negative trend in maintenance findings and/or costs
- Expected service life (at or beyond) or obsolescence

*Substation Condition Rebuild / Replacement*

- Circuit breakers and other fault interrupting equipment

**Problem Statement**

**Sharon 138 kV Substation**

- Increasing maintenance costs for 138 kV breakers B-48 and B-60
- Breakers B-48 and B-60 are over 30 years old
- CCVT's are over 25 years old

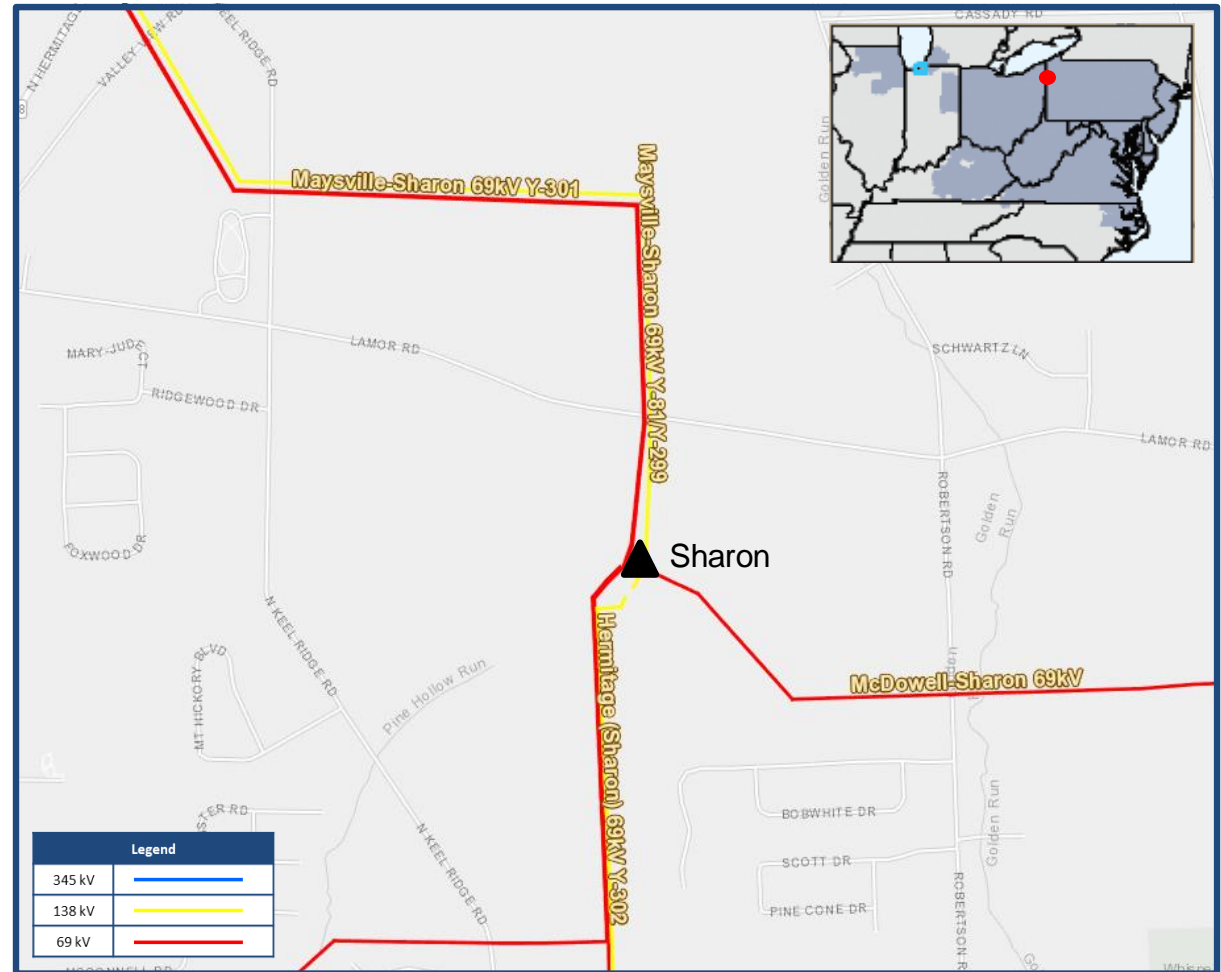





# ATSI Transmission Zone M-3 Process Sharon Substation 138 kV Solution

**Need Number:** ATSI-2019-069 (s2263)  
**Process Stage:** Submission of Supplemental Project for Inclusion in the Local Plan – 09/25/2020  
**Previously Presented:** Need Meeting – 07/24/2019  
 Solution Meeting – 05/22/2020

**Proposed Solution:**

**Sharon Substation 138 kV Breakers**

- Upgrade Sharon 138 kV breaker B48 and B60, and associated disconnect switches
- Upgrade relays associated with B48
- Replace the B48 CCVT and the Sharon-Shenango 138 kV Line CCVT
- Upgrade substation conductor to exceed transmission line ratings

**Transmission Line Ratings:**

▪ **Sharon 138 kV North Bus-South Bus**

- Before Proposed Solution: 191 MVA SN / 191 MVA SE
- After Proposed Solution: 278 MVA SN / 339 MVA SE

▪ **Sharon-Shenango 138 kV Line**

- Before Proposed Solution: 176 MVA SN / 229 MVA SE
- After Proposed Solution: 265 MVA SN / 316 MVA SE

**Alternative Considered:**

- Maintain existing equipment and risk of failure

**Estimated Project Cost:** \$1.3 M

**Projected In-Service:** 12/31/2021

**Status:** Conceptual

**No changes in topology;  
No bubble diagram required.**

Legend	
500 kV	
345 kV	
138 kV	
69 kV	
34.5 kV	
23 kV	
New	

**Need Number:** ATSI-2020-003 (s2264)  
**Process Stage:** Submission of Supplemental Project for Inclusion in the Local Plan – 09/25/2020  
**Previously Presented:** Need Meeting – 04/20/2020  
 Solution Meeting – 05/22/2020

**Supplemental Project Driver(s):**  
*Customer Service*

**Specific Assumption Reference(s):**  
 Modification of existing customer connection request evaluated per FirstEnergy's "Requirements for Transmission Connected Facilities" document and "Transmission Planning Criteria" document.

**Problem Statement:**  
 New Customer Connection – A customer requested 138 kV transmission service for approximately 95 MVA of total load near the Highland-GM Lordstown 138 kV Line.

**Requested In-Service Date:** 07/01/2021

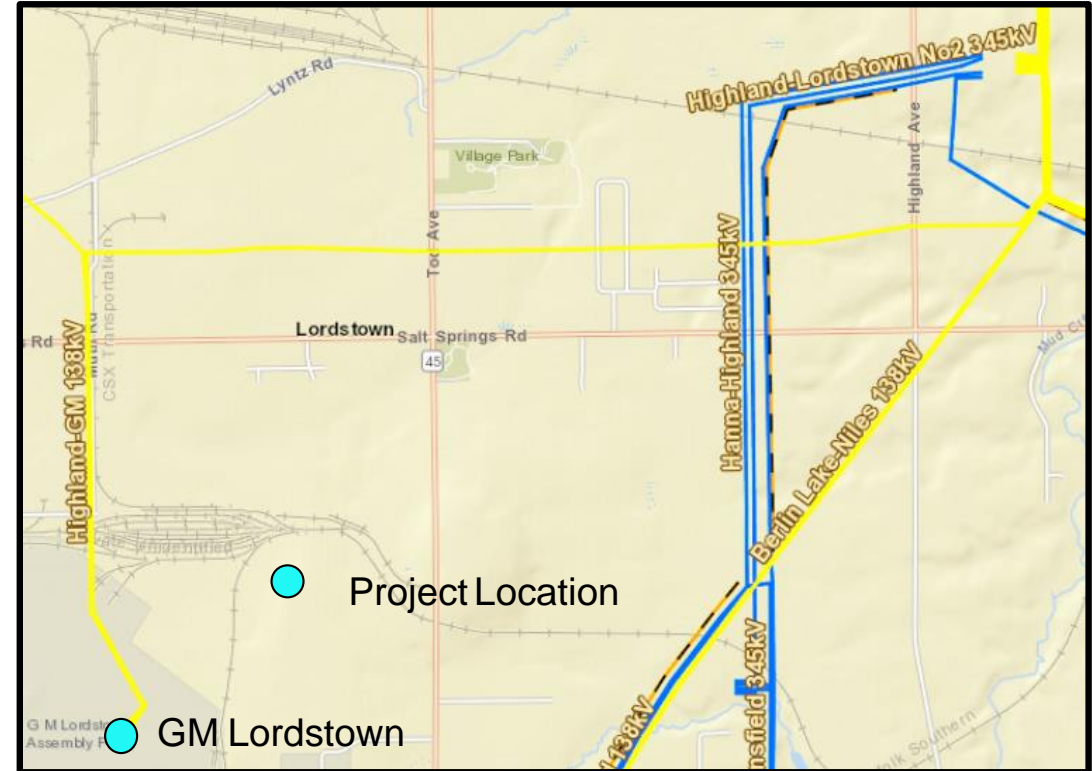

Legend	
345 kV	
138 kV	
69 kV	

**Need Number:** ATSI-2020-003 (s2264)  
**Process Stage:** Submission of Supplemental Project for Inclusion in the Local Plan – 09/25/2020  
**Previously Presented:** Need Meeting – 04/20/2020  
 Solution Meeting – 05/22/2020

### Proposed Solution

#### **Magellan 138 kV Breaker and a Half**

- Construct a 138 kV 11-breaker breaker-and-a-half (future 12-breaker) substation
- Loop the Highland-GM Lordstown 138 kV Line by building approximately 0.5 miles of 138 line using 795 ACSR near structure 3069
- Provide three 138 kV metering package
- Install two capacitors totaling 86.4 MVAR @ 144.1 kV (multiple step)
- Build roughly 3.5 miles of 138 kV line from Highland to Magellan using 795 ACSR utilizing an open arm position on the Highland-Lordstown #1 345 kV Line

### Transmission Line Ratings:

- **Highland-Magellan #1 138 kV Line**
  - After Proposed Solution: 329 MVA SN / 413 MVA SE
- **Highland-Magellan #2 138 kV Line**
  - After Proposed Solution: 275 MVA SN / 333 MVA SE
- **GM Lordstown-Magellan 138 kV Line**
  - After Proposed Solution: 267 MVA SN / 352 MVA SE

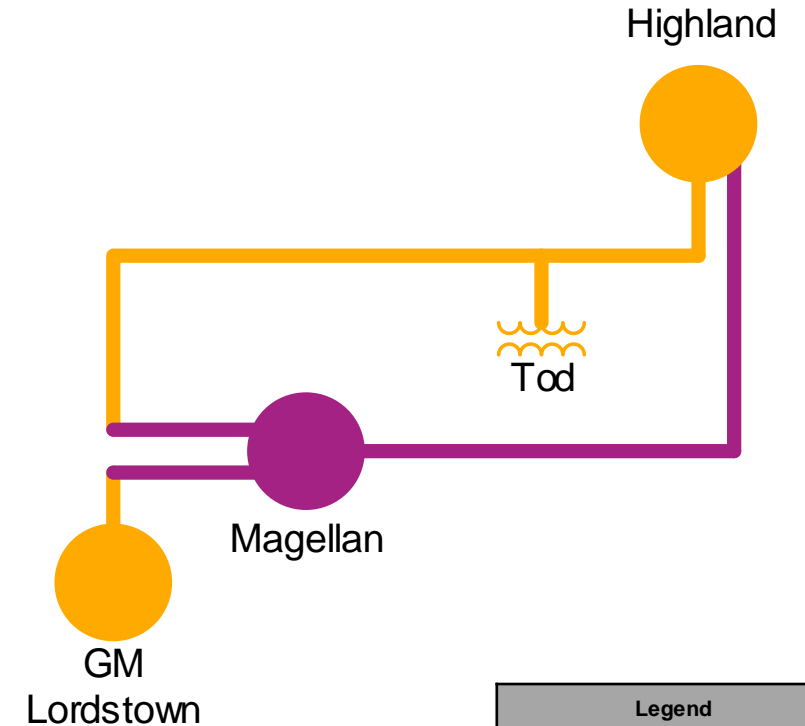

Legend	
500 kV	
345 kV	
138 kV	
69 kV	
34.5 kV	
23 kV	
New	

Continued on next slide...



# ATSI Transmission Zone M-3 Process Magellan New Customer Solution

**Need Number:** ATSI-2020-003 (s2264)  
**Process Stage:** Submission of Supplemental Project for Inclusion in the Local Plan – 09/25/2020  
**Previously Presented:** Need Meeting – 04/20/2020  
 Solution Meeting – 05/22/2020

**Alternatives Considered:**

- Provide service via 5-breaker ring bus (criteria violations identified)
- Provide service via a 345/138 kV substation (not needed for studied load level)

**Estimated Project Cost:** \$31.8 M

**Projected In-Service:** 07/01/2021  
**Status:** Engineering  
**Model:** 2019 Series 2024 Summer RTEP 50/50

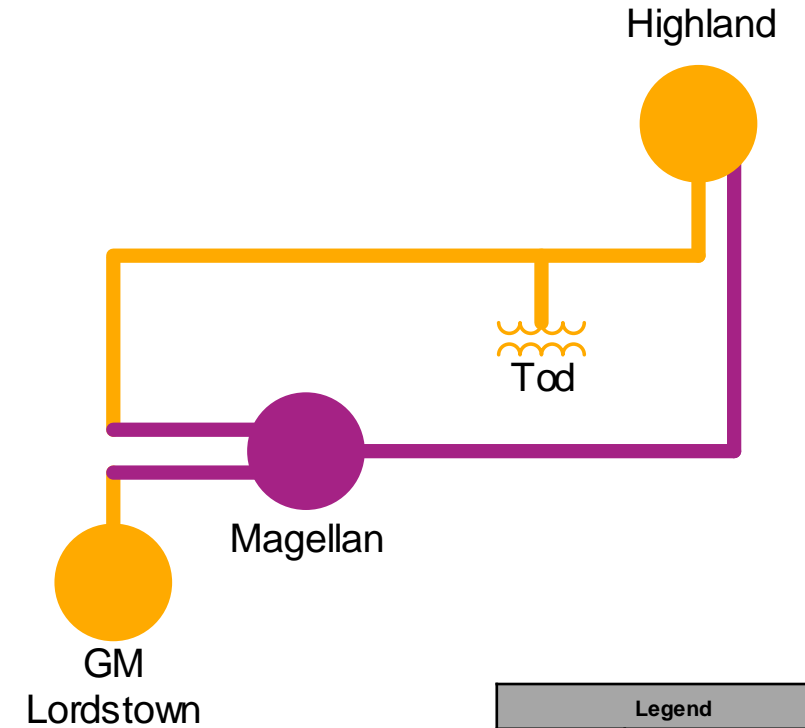

Legend	
500 kV	
345 kV	
138 kV	
69 kV	
34.5 kV	
23 kV	
New	

**Need Number:** ATSI-2020-001 (s2265)  
**Process Stage:** Submission of Supplemental Project for Inclusion in the Local Plan – 09/25/2020  
**Previously Presented:** Needs Meeting – 01/17/2020  
 Solution Meeting – 05/22/2020

**Project Driver(s):**  
*Operational Flexibility and Efficiency*  
*Infrastructure Resilience*

**Specific Assumption Reference(s)**

**Global Considerations**

- System reliability and performance
- Substation / Line equipment limits
- Reliability of Non-Bulk Electric System (Non-BES) facilities
- Load and risk in planning and operational scenarios
- Load and/or customers at risk on single transmission lines

**Network Radial Lines**

- Load at risk and/or customers affected
- Proximity to other networked facilities

**Automatic Sectionalizing Schemes**

- Load at risk and/or customers affected

**Problem Statement**

**Streetsboro 69 kV Substation and System Configuration**

- Streetsboro is a straight 69 kV bus with no breakers or interrupting devices.
- The Ravenna-Lake Rockwell 69 kV line (approximately 7.59 miles) is a radial line; normally open point near Streetsboro substation.
- Customers and load at risk: Approximately 5,000 customers / 25 MWs

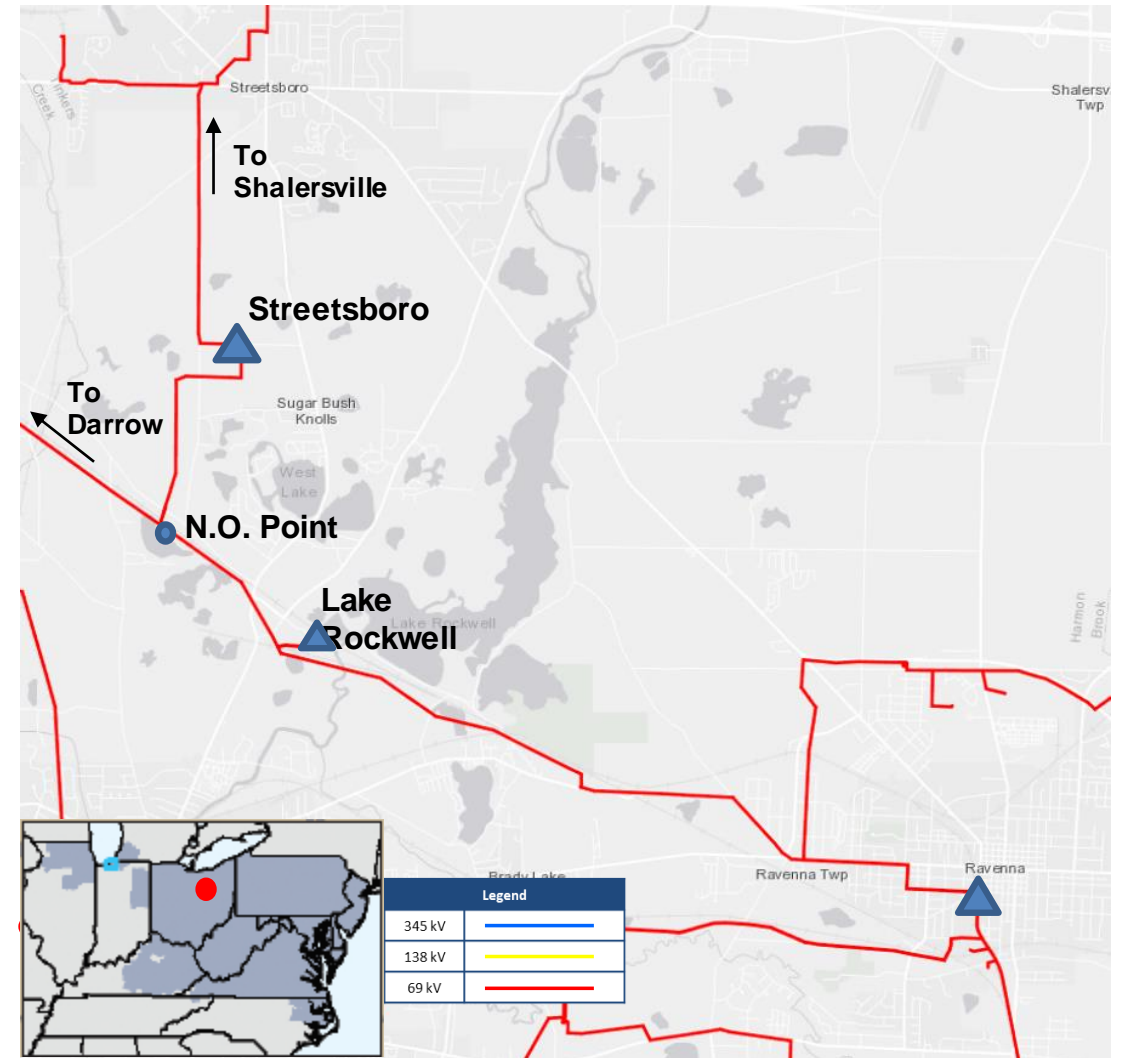



# ATSI Transmission Zone M-3 Process Streetsboro 69 kV Area Solution

**Need Number:** ATSI-2020-001 (s2265)  
**Process Stage:** Submission of Supplemental Project for Inclusion in the Local Plan – 09/25/2020  
**Previously Presented:** Needs Meeting – 01/17/2020  
 Solution Meeting – 05/22/2020

### Proposed Solution:

Related to supplemental project s1212

Convert the Streetsboro 69 kV straight bus to a five-circuit breaker ring bus. Build a double circuit approximately 1.8 miles 69 kV line from Streetsboro sub to eliminate the three terminal line and create Darrow-Streetsboro (~6.7 miles) and Ravenna-Streetsboro (~8.6 miles) 69 kV lines.

### Transmission Line Ratings:

- Darrow-Streetsboro 69 kV Line
  - After Proposed Solution: 76 MVA SN / 92 MVA SE
- Ravenna-Streetsboro 69 kV Line
  - After Proposed Solution: 45 MVA SN / 54 MVA SE

### Alternatives Considered:

Keep the existing configuration with elevated risk

**Estimated Project Cost:** \$10.1 M

**Projected In-Service:** June 1, 2020

**Project Status:** Construction

**Model:** 2019 RTEP 2024 case

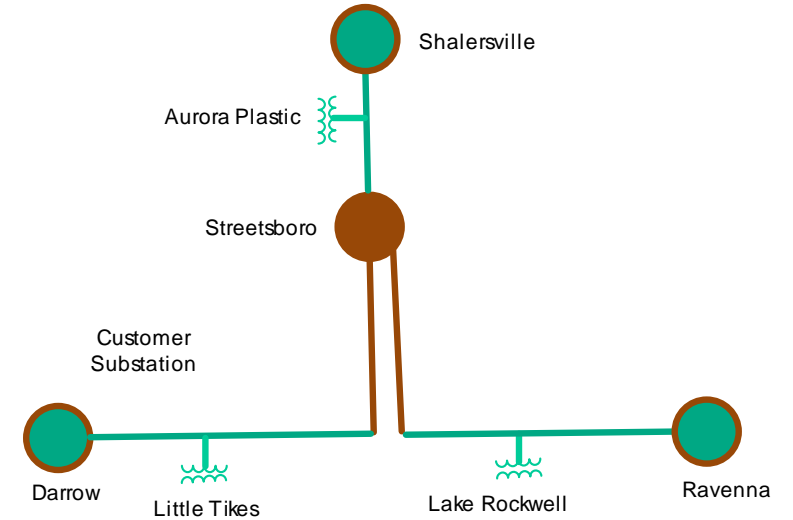

Legend	
500 kV	
345 kV	
138 kV	
69 kV	
34.5 kV	
23 kV	
New	

**Need Number:** ATSI-2020-004  
**Process Stage:** Submission of Supplemental Project for Inclusion in the Local Plan – 10/16/2020  
**Previously Presented:** Need Meeting – 04/20/2020  
 Solution Meeting – 06/19/2020

**Supplemental Project Driver(s):**  
*Operational Flexibility and Efficiency*  
*Equipment Material Condition, Performance and Risk*  
*Infrastructure Resilience*

**Specific Assumption Reference(s)**

**Global Considerations**

- System Reliability and Performance
- Load at risk in planning and operational scenarios

**Substation Condition Rebuild/Replacement**

- Increasing negative trend in maintenance findings and/or costs.
- Expected service life (at or beyond) or obsolescence

**Add/Expand Bus Configuration**

- Loss of substation bus adversely impacts transmission system performance
- Eliminate simultaneous outages to multiple networked elements under N-1 analysis
- Capability to perform system maintenance

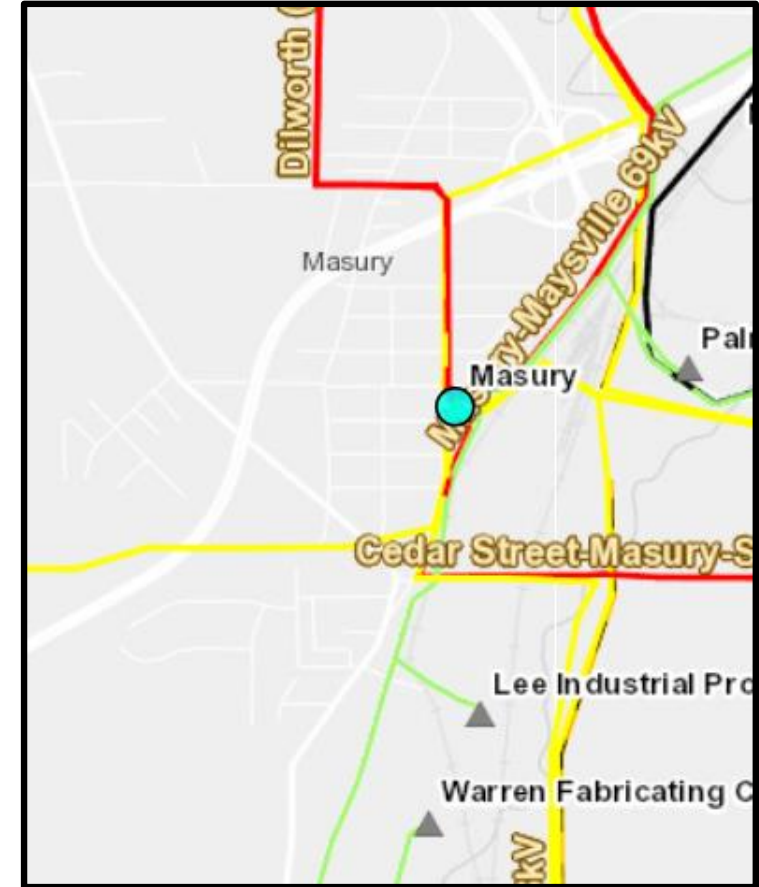

Legend	
345 kV	
138 kV	
69 kV	

Continued on next slide...



**Need Number:** ATSI-2020-004  
**Process Stage:** Submission of Supplemental Project for Inclusion in the Local Plan – 10/16/2020  
**Previously Presented:** Need Meeting – 04/20/2020  
 Solution Meeting – 06/19/2020

**Problem Statement**

Masury 138 kV Substation

- System analysis shows that after a Masury 138 kV bus fault, a substantial amount of load is at risk (~42 MW)
- Masury 138 kV bus fault ATSI-P1-2-OEE-138-024 outages five 138 kV lines, two 138/69 kV transformers, and two 138-23 kV transformers
- There have been five pre-contingency switching events in the past year for the Masury 23 kV area
- Five (5) 138 kV OCB breakers (B2, B85, B101, B87, and B6) at Masury are showing end of life characteristics;
  - Deteriorated bushings
  - Deteriorated mechanism
  - Oil leaks
  - Age (>30 years) with increasing maintenance
  - Obsolescence of equipment and spare parts
- Masury 138 kV bus protection currently employs a bus blocking scheme which is not the FE standard protection scheme

**Model:** 2019 Series 2024 Summer RTEP 50/50

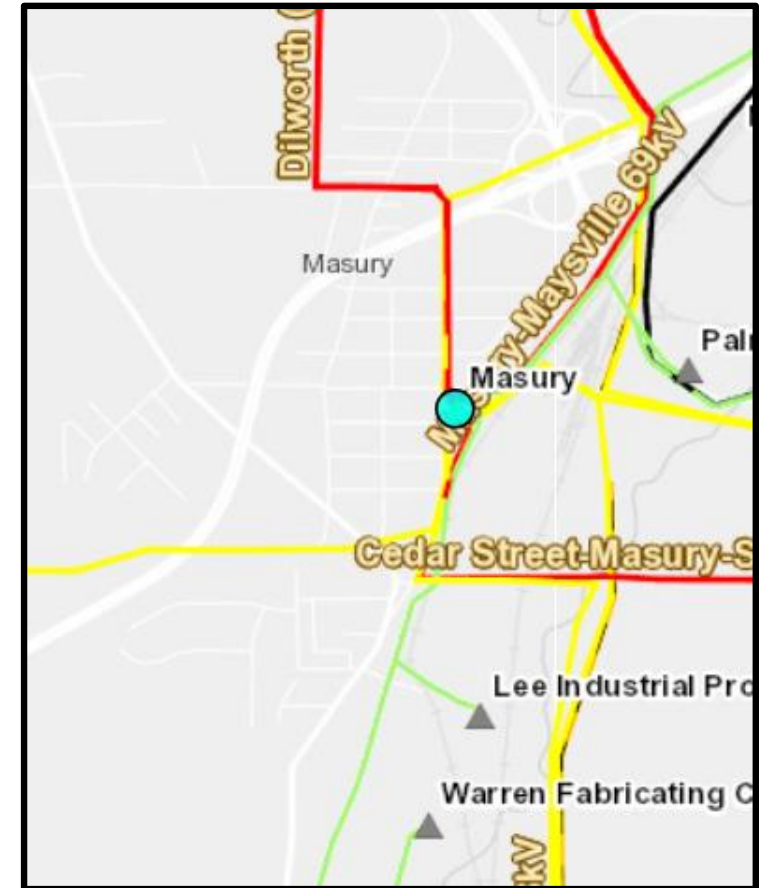

Legend	
345 kV	
138 kV	
69 kV	

# ATSI Transmission Zone M-3 Process Masury 138 kV Substation

**Need Number:** ATSI-2020-004  
**Process Stage:** Submission of Supplemental Project for Inclusion in the Local Plan – 10/16/2020  
**Previously Presented:** Need Meeting – 04/20/2020  
 Solution Meeting – 06/19/2020

**Selected Solution:**

**Masury Bus Tie Breaker**

- Replace bus disconnect switch with one 138 kV bus-tie breaker
- Replace 138 kV breaker B2
- Replace 138 kV breaker B85
- Replace 138 kV breaker B101
- Replace 138 kV transfer-bus breaker B6
- Replace 138 kV breaker B87
- Upgrade substation conductor at Masury

**Transmission Line Ratings:**

- **Masury-Salt Springs 138 kV Line**
  - Before Proposed Solution: 128 MVA SN / 165 MVA SE
  - After Proposed Solution: 185 MVA SN / 189 MVA SE
- **Masury-Ellwood Engineering Tap 138 kV Line Segment**
  - Before Proposed Solution: 128 MVA SN / 165 MVA SE
  - After Proposed Solution: 164 MVA SN / 206 MVA SE

**Estimated Project Cost:** \$2.96 M  
**Projected In-Service:** 06/01/2023  
**Supplemental Project ID:** s2294  
**Model:** 2019 Series 2024 Summer RTEP 50/50

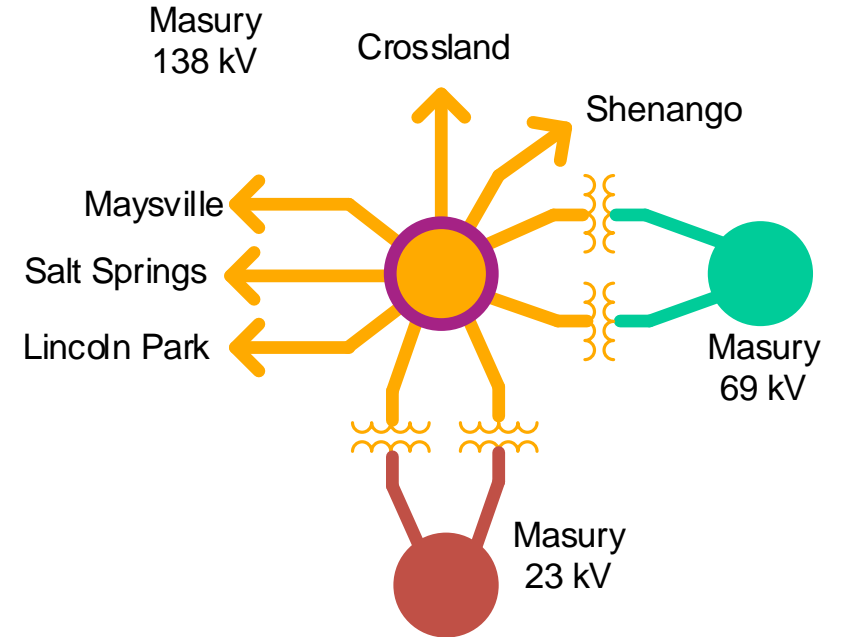

Legend	
500 kV	
345 kV	
138 kV	
69 kV	
34.5 kV	
23 kV	
New	

**Need Number:** ATSI-2020-009  
**Process Stage:** Submission of Supplemental Project for Inclusion in the Local Plan – 10/16/2020  
**Previously Presented:** Need Meeting – 05/22/2020  
 Solution Meeting – 06/19/2020

**Supplemental Project Driver(s):**  
*Customer Service*

**Specific Assumption Reference(s)**

Modification of existing customer connection request evaluated per FirstEnergy’s “Requirements for Transmission Connected Facilities” document and “Transmission Planning Criteria” document.

**Problem Statement**

New Customer Connection – A customer requested 69 kV transmission service for approximately 9 MW of total load near the Boardman-Lowellville # 2 69 kV Line.

**Requested In-Service Date:** 11/26/2020



Legend	
345 kV	
138 kV	
69 kV	

**Need Number:** ATSI-2020-009  
**Process Stage:** Submission of Supplemental Project for Inclusion in the Local Plan – 10/16/2020  
**Previously Presented:** Need Meeting – 05/22/2020  
 Solution Meeting – 06/19/2020

**Selected Solution:**

**A 69 kV Transmission Line Tap**

- Construct approximately one to two spans of 69 kV line off a currently existing tap on the Boardman-Lowellville # 2 69 kV Line. The tap location is approximately 8 miles from Boardman substation.
- Provide two loss compensated electronic interval meters.

**Estimated Project Cost:** \$0.4 M

**Projected In-Service:** 11/26/2020

**Supplemental Project ID:** s2295

**Model:** 2019 Series 2024 Summer RTEP 50/50

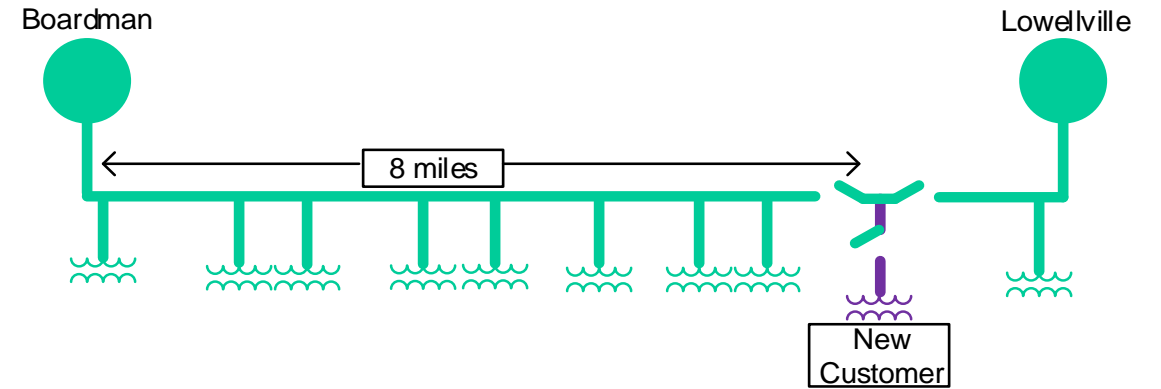

Legend	
500 kV	
345 kV	
138 kV	
69 kV	
34.5 kV	
23 kV	
New	

**Need Number:** ATSI-2020-010  
**Process Stage:** Submission of Supplemental Project for Inclusion in the Local Plan – 10/16/2020  
**Previously Presented:** Need Meeting – 05/22/2020  
 Solution Meeting – 06/19/2020

**Supplemental Project Driver(s):**  
*Customer Service*

**Specific Assumption Reference(s)**

Modification of existing customer connection request evaluated per FirstEnergy’s “Requirements for Transmission Connected Facilities” document and “Transmission Planning Criteria” document.

**Problem Statement**

New Customer Connection – A customer requested 138 kV transmission service for approximately 10 MW of total load near the New Castle-Cedar Street 138 kV Line.

**Requested In-Service Date:** 11/25/2020

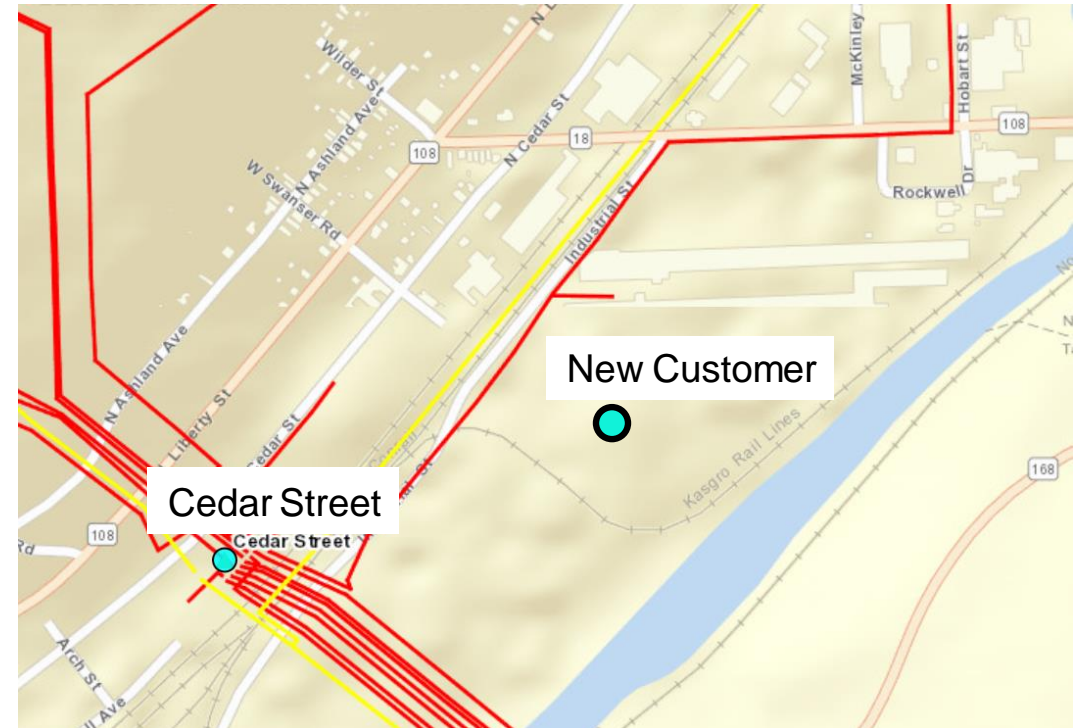

Legend	
345 kV	
138 kV	
69 kV	



# ATSI Transmission Zone M-3 Process Cedar Street-New Castle 138 kV New Customer

**Need Number:** ATSI-2020-010  
**Process Stage:** Submission of Supplemental Project for Inclusion in the Local Plan – 10/16/2020  
**Previously Presented:** Need Meeting – 05/22/2020  
 Solution Meeting – 06/19/2020

**Selected Solution:**

***A 138 kV Transmission Line Tap***

- Construct a 138 kV tap (approximately one to two spans) off the Cedar Street-New Castle 138 kV Line to the customer substation. The customer substation tap location is approximately 0.1 miles from the Cedar Street substation. Provide one 138 kV metering package.

**Estimated Project Cost:** \$2.7 M

**Projected In-Service:** 11/25/2020

**Model:** 2019 Series 2024 Summer RTEP 50/50

**Supplemental Project ID:** s2296

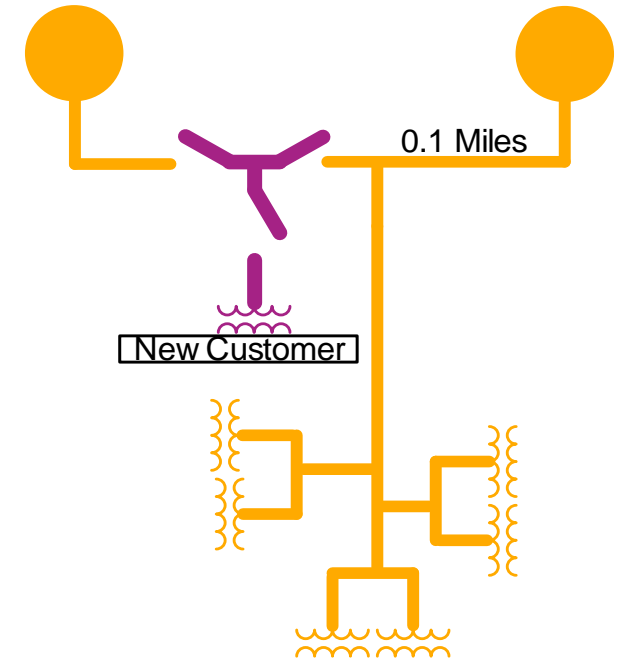

Legend	
500 kV	
345 kV	
138 kV	
69 kV	
34.5 kV	
23 kV	
New	



**Need Number:** ATSI-2020-007  
**Process Stage:** Submission of Supplemental Project for Inclusion in the Local Plan – 10/16/2020  
**Previously Presented:** Need Meeting – 05/22/2020  
 Solution Meeting – 07/17/2020

**Supplemental Project Driver(s):**

*Operational Flexibility and Efficiency  
 Equipment Material Condition, Performance and Risk  
 Infrastructure Resilience*

**Specific Assumption Reference(s):**

**Global Considerations**

- System reliability and performance
- Load at risk in planning and operational scenarios

**Substation Condition Rebuild/Replacement**

- Increasing negative trend in maintenance findings and/or costs
- Expected service life (at or beyond) or obsolescence

**Add/Expand Bus Configuration**

- Loss of substation bus adversely impacts transmission system performance
- Eliminate simultaneous outages to multiple networked elements under N-1 analysis
- Capability to perform system maintenance

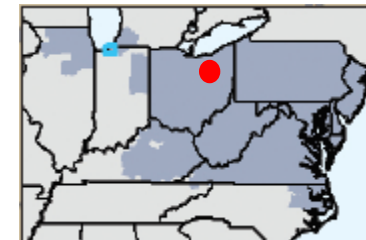
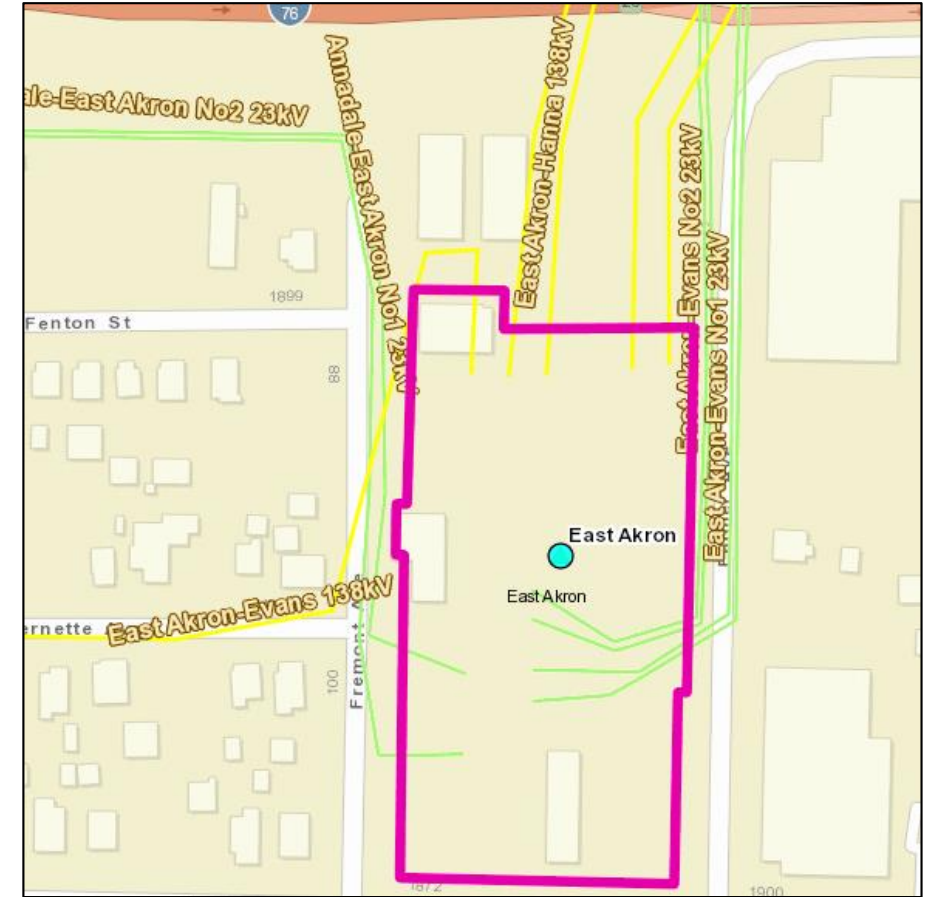

Legend	
345 kV	
138 kV	
69 kV	



**Need Number:** ATSI-2020-007

**Process Stage:** Submission of Supplemental Project for Inclusion in the Local Plan – 10/16/2020

**Previously Presented:** Need Meeting – 05/22/2020  
Solution Meeting – 07/17/2020

### Problem Statement (continued)

- East Akron-West Ravenna 138 kV line has been previously identified on the list of mis-operation relays (s1972)
- Associated terminal equipment line arrestors, wave trap, line tuner, CCVTs:
  - Older equipment has slower operating times and can produce longer duration of fault current
  - O&M costs increasing due to maintenance of older equipment

### Power flow analysis:

- Breaker B-22 overdutied (102.1%) of its interrupting rating in PJM’s 2019 RTEP 2024 generation reactivation study
- Breaker B-43 overdutied (102.9%) of its interrupting rating in PJM’s No-Harm analysis of ATSI-2019-10 (FESub5 project).
- Breaker B-46 overdutied (103.0%) of its interrupting rating in PJM’s No-Harm analysis of ATSI-2019-10 (FESub5 project).

### System Performance

Over the past five years:

The East Akron 138 kV lines or bus has experienced three momentary outages and seven sustained outages.

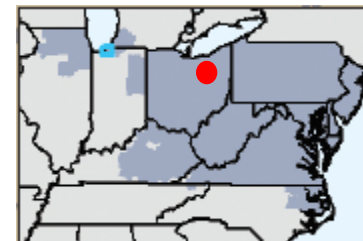
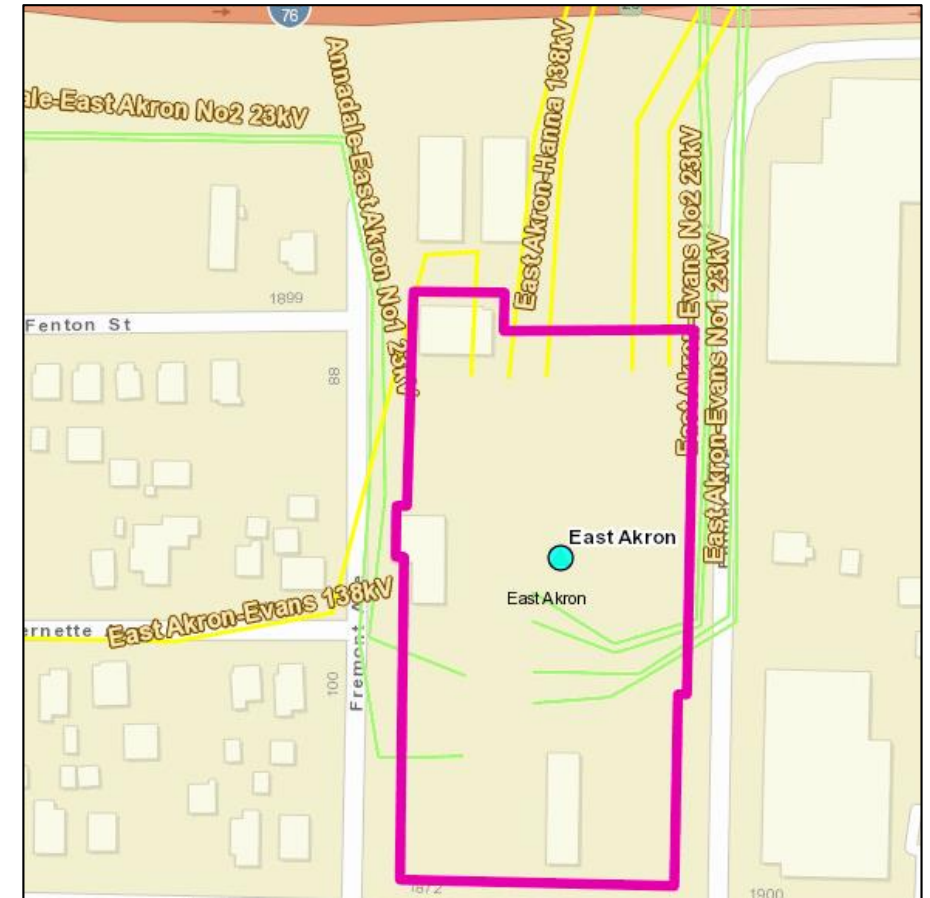

Legend	
345 kV	
138 kV	
69 kV	



**Need Number:** ATSI-2020-007  
**Process Stage:** Submission of Supplemental Project for Inclusion in the Local Plan – 10/16/2020  
**Previously Presented:** Need Meeting – 05/22/2020  
 Solution Meeting – 07/17/2020

**Selected Solution:**

- Convert East Akron 138 kV Substation into Breaker and Half configuration
- Install a new control building.
- Re-use two (2) breakers (B75 & 76)
- Upgrade three (3) breakers (B43, B46 and B253) with 138 kV, 40 kA, SF6 circuit breaker
- Install seven (7) additional 138 kV, 40 kA, SF6 circuit breakers
- Replace and install switches, surge arrestors, CVT's, SSVT's
- Upgrade wave trap on Knox exit, replace line tuner and coax

**Transmission Line Ratings:**

- East Akron-Hanna 138 kV Line
  - Before Proposed Solution: 221 MVA SN / 262 MVA SE
  - After Proposed Solution: 233 MVA SN / 282 MVA SE

**Estimated Project Cost:** \$13.8 M

**Projected IS Date:** 12/30/2023

**Supplemental Project ID:** s2297

## ATSI Transmission Zone M-3 Process East Akron 138 kV Substation

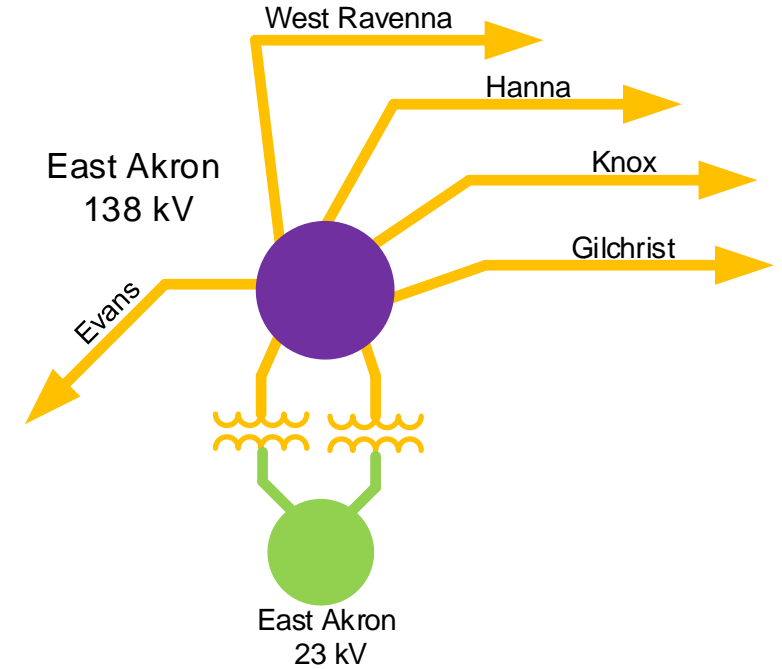

Legend	
500 kV	
345 kV	
138 kV	
69 kV	
34.5 kV	
23 kV	
New	

**Need Number:** ATSI-2020-008

**Process Stage:** Submission of Supplemental Project for Inclusion in the Local Plan – 10/16/2020

**Previously Presented:** Need Meeting – 05/22/2020  
Solution Meeting – 07/17/2020

**Supplemental Project Driver(s):**

*Operational Flexibility and Efficiency*  
*Equipment Material Condition, Performance and Risk*  
*Infrastructure Resilience*

**Specific Assumption Reference(s)**

**Global Considerations**

- System reliability and performance
- Load at risk in planning and operational scenarios

**Substation Condition Rebuild/Replacement**

- Increasing negative trend in maintenance findings and/or costs
- Expected service life (at or beyond) or obsolescence

**Add/Expand Bus Configuration**

- Loss of substation bus adversely impacts transmission system performance
- Eliminate simultaneous outages to multiple networked elements under N-1 analysis
- Capability to perform system maintenance

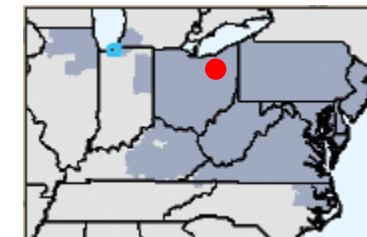
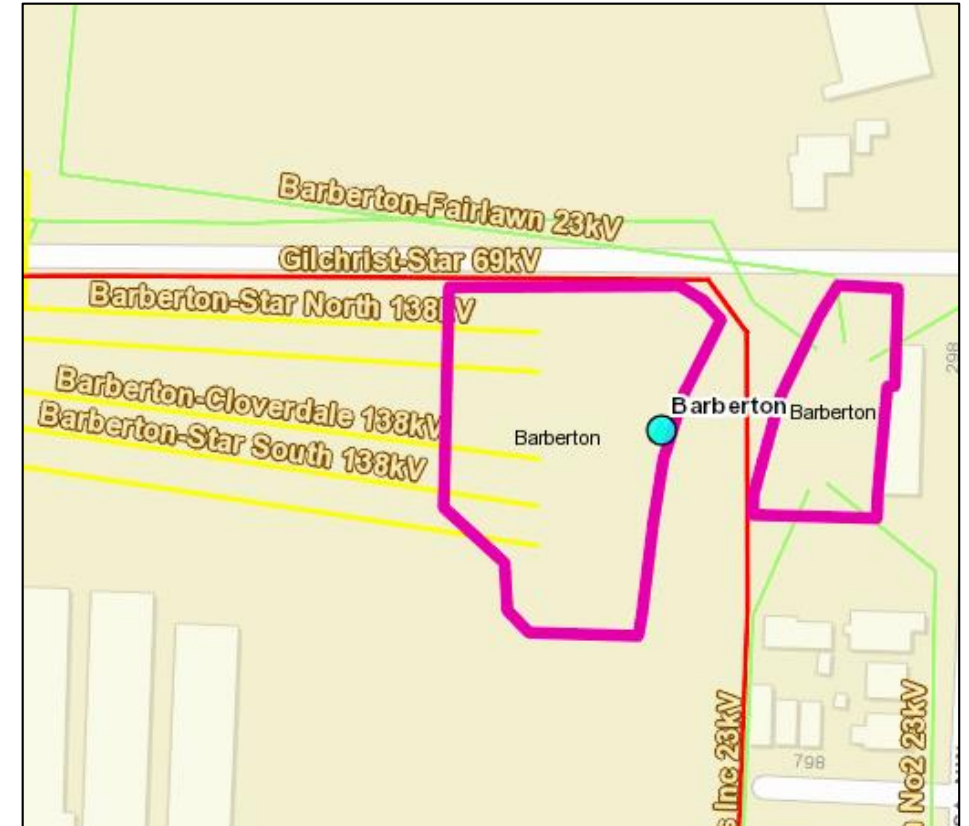

Legend	
345 kV	
138 kV	
69 kV	



**Need Number:** ATSI-2020-008  
**Process Stage:** Submission of Supplemental Project for Inclusion in the Local Plan – 10/16/2020  
**Previously Presented:** Need Meeting – 05/22/2020  
 Solution Meeting – 07/17/2020

**Problem Statement (continued)**

Barberton 138 kV configuration and condition:

- Barberton 138 kV substation is a main and transfer bus configuration substation
  - A fault on the bus or between the bus and the circuit breaker or a failure of a single circuit breaker or a failure of a relay to trip will result in an outage of the entire bus or substation interrupting five 138 kV lines and two 138-23 kV transformers

Deteriorating control building and substation equipment:

- The control house was built in 1927, 93 years old.
  - Does not have space for new cables and additional panels.
  - The cables from the 138 kV yard run through an older tunnel under the railroad property to the control house in the distribution yard. The cables in the tunnel can't be removed because they are encased in mineral deposits.
  - The control house has the panels on the second story and poses a challenge to replace and/or maintain the panels.

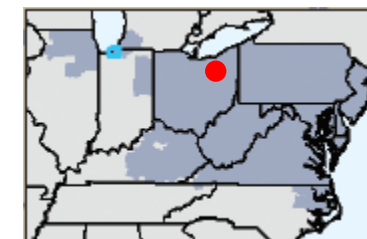
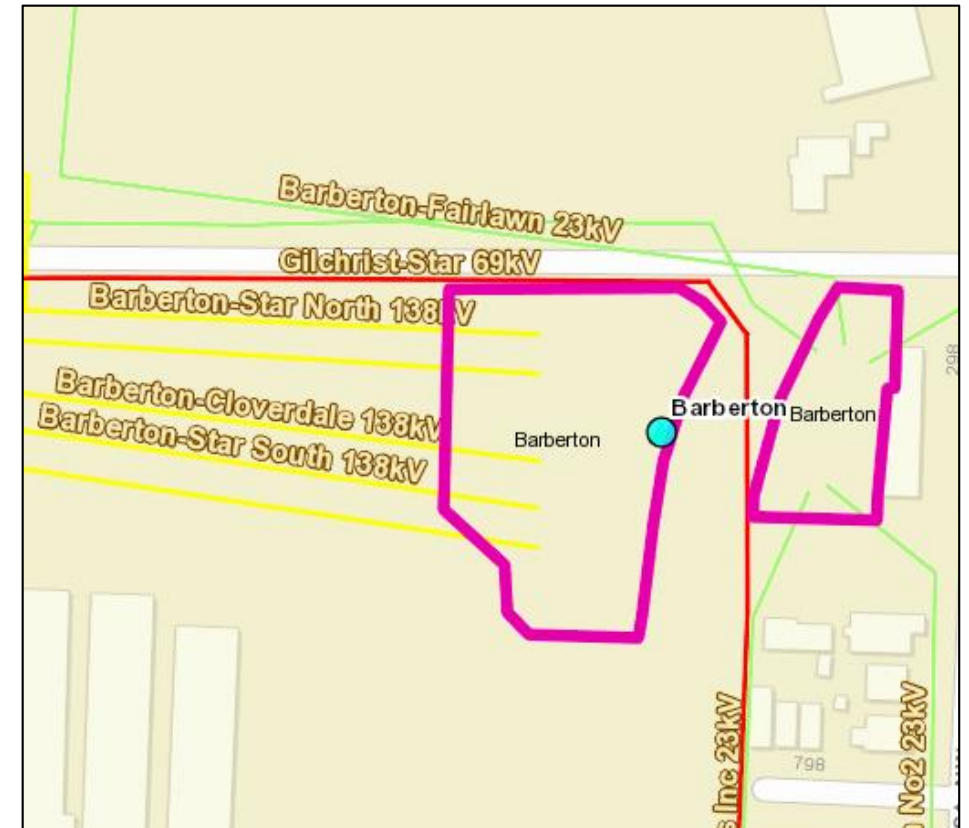

Legend	
345 kV	
138 kV	
69 kV	



**Need Number:** ATSI-2020-008  
**Process Stage:** Submission of Supplemental Project for Inclusion in the Local Plan – 10/16/2020  
**Previously Presented:** Need Meeting – 05/22/2020  
 Solution Meeting – 07/17/2020

**Problem Statement (continued)**

Breaker conditions:

- Oil circuit breakers (OCB) B-124, B-37, B-45, and B-74 are at/beyond expected service life (greater than 45 years) with increasing maintenance concerns; air leaks, deteriorated operating mechanisms, CCPD failures, deteriorated bushings, and increasing maintenance trends
- Associated terminal equipment line arrestors, wave trap, line tuner, CCVTs:
  - Older equipment has slower operating times and can produce longer duration of fault current
  - O&M cost increasing due to maintenance of older equipment

**Protection Scheme:**

- Barberton 138 kV breakers B-124, B-37, B-45, B-74, B-75 do not have enough CTs for separate inputs to a primary and backup differential scheme.

**System Performance**

Over the past five years:

The Barberton 138 kV lines or bus has experienced four momentary outages and nine sustained outages.

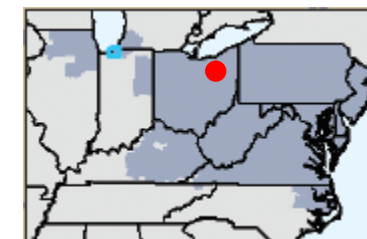
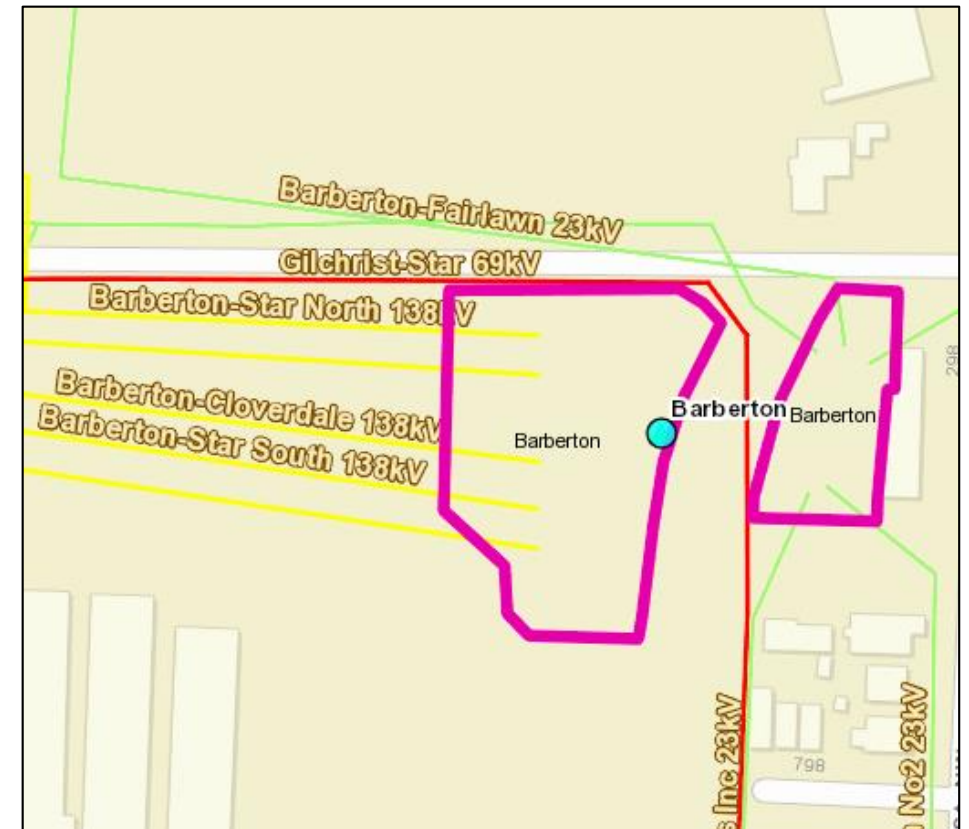

Legend	
345 kV	
138 kV	
69 kV	



**Need Number:** ATSI-2020-008  
**Process Stage:** Submission of Supplemental Project for Inclusion in the Local Plan – 10/16/2020  
**Previously Presented:** Need Meeting – 05/22/2020  
 Solution Meeting – 07/17/2020

**Selected Solution:**

- Convert Barberton 138 kV Substation into Double Bus Double breaker configuration
- Install a new control building
- Re-use two (2) breakers (B75 & 76)
- Upgrade five (5) breakers (B124, B45, B74, B37 & B357) with 138 kV, 40 kA, SF6 circuit breaker
- Install nine (9) additional 138 kV, 40 kA, SF6 circuit breakers
- Replace and install switches, surge arrestors, CVT's, SSVT's
- Upgrade less than 0.1 miles section of the Barberton-West Akron 138 kV line from 605 kcmil ACSR conductor to 795 kcmil ACSS conductor

**Transmission Line Ratings:**

- Barberton-West Akron 138 kV Line
  - Before Proposed Solution: 233 MVA SN / 282 MVA SE
  - After Proposed Solution: 310 MVA SN / 357 MVA SE

**Estimated Project Cost:** \$14.7 M

**Projected IS Date:** 12/30/2023

**Supplemental Project ID:** s2298

## ATSI Transmission Zone M-3 Process Barberton 138 kV Substation

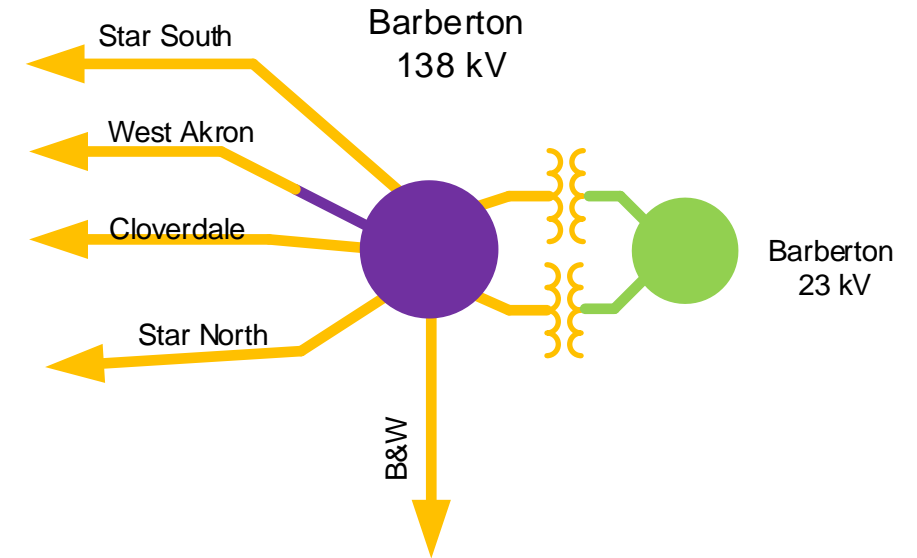

Legend	
500 kV	
345 kV	
138 kV	
69 kV	
34.5 kV	
23 kV	
New	

# Revision History

3/18/2020– V1 – Local Plan posted to pjm.com

6/8/2020– V2 – Added: S2227-S2243

7/2/2020– V3 – Added: S2245, S2246, S2259, S2260

10/1/2020– V4 – Added: S2261 – S2265

10/16/2020– V5 – Added: S2294-S2298