



# PJM Solution Proposal Framework Changes

# Attachment EE

Ed Franks  
Senior Lead Engineer  
Interconnection Analysis

- Attachment EE - Upgrade Requests to upgrade existing PJM transmission facilities
  - Examples: Relieve congestion, request IARRs, request ICTRs
  - Presently come through the PJM New Services Queue
- Attachment EE – propose a separate process from the interconnection process with goal to complete processing of these requests in ~ 1 year
  - No Attachment EE window, these requests can be submitted at any time
  - The requested upgrade scope cannot be part of an already executed ISA or UCSA

# Upgrade Requests (Att. EE) – Transition to Proposed Interconnection Process

Total time – ~15 months

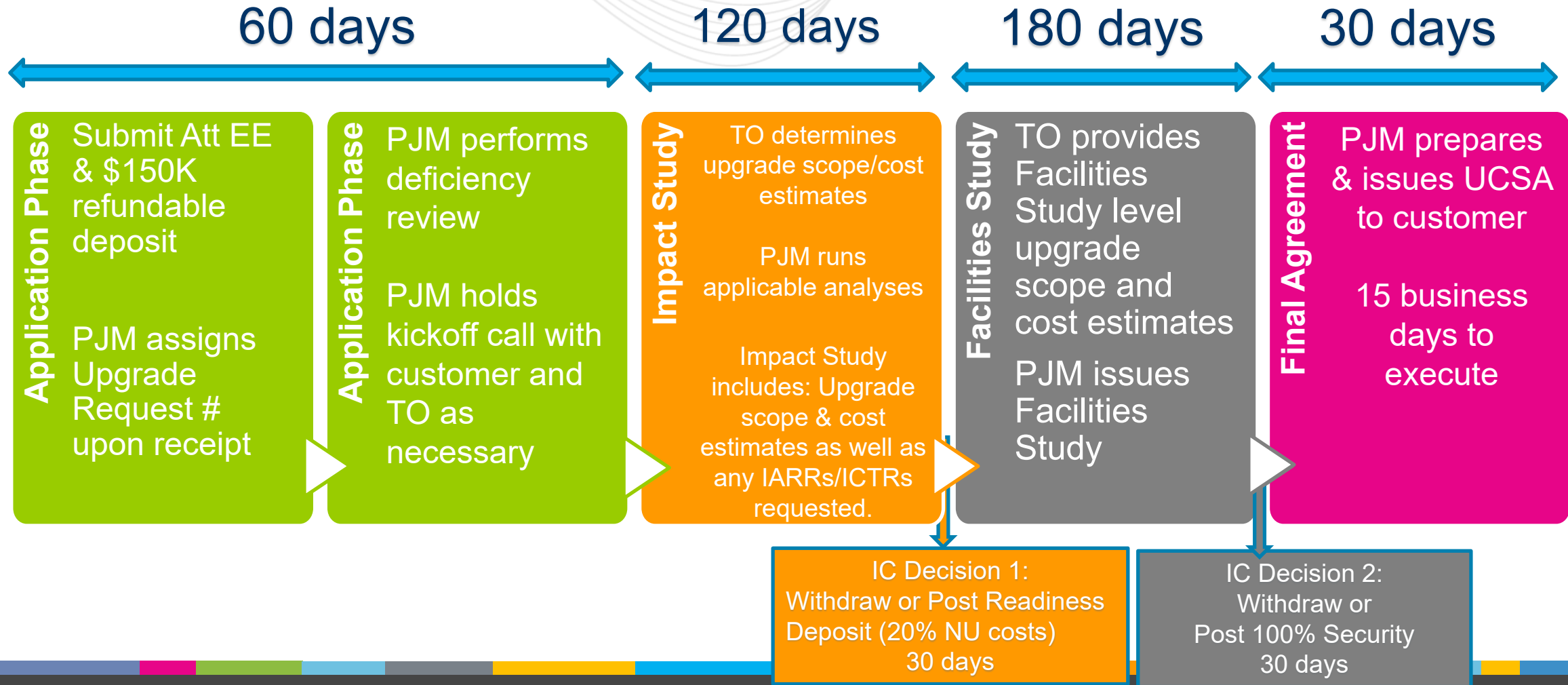

# Site Control

Lisa Krizenoskas  
Senior Lead Engineer  
Interconnection Projects

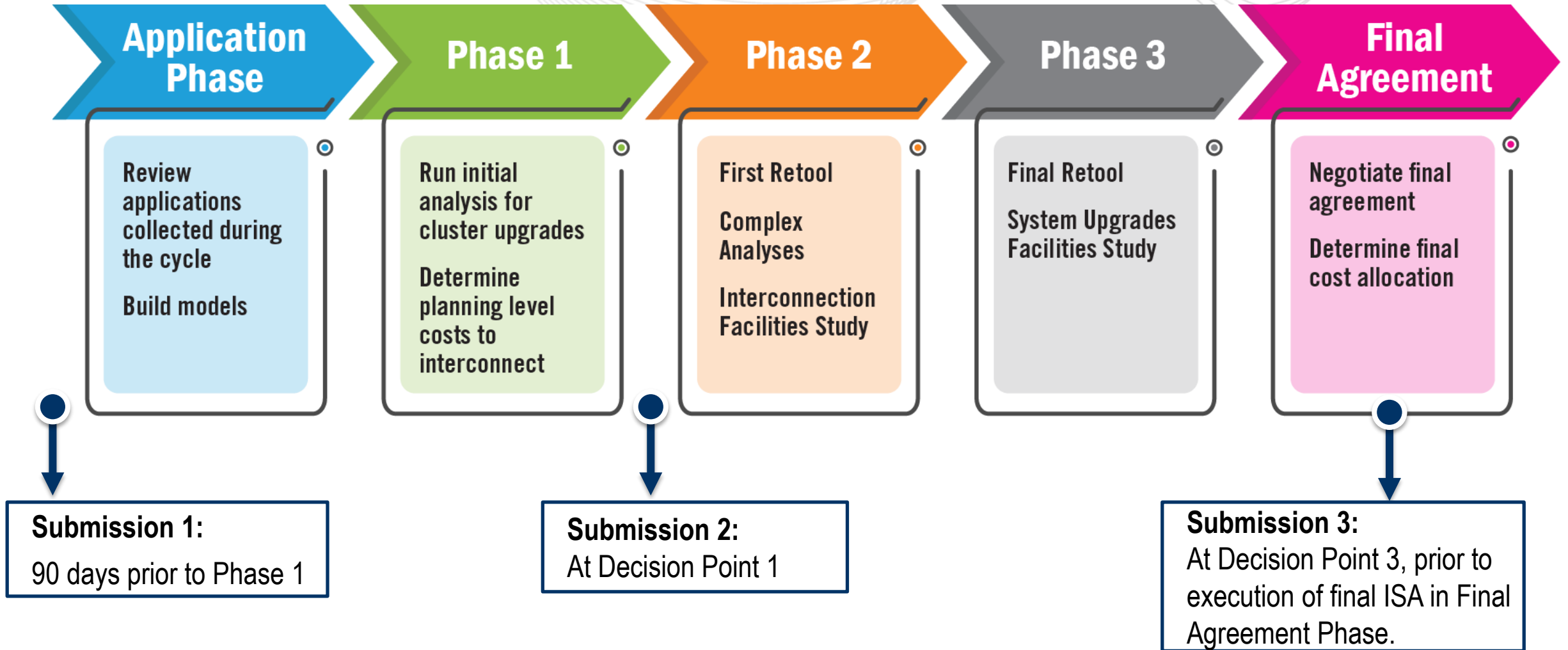

## 5 year requirement from last day of Phase 3 (Submission 3)

- Developers should be in a position to be ready to sign lease at the Agreement Phase.
- Developers may need to modify lease agreements going forward to align the option with PJM new requirements.
- PJM needs to ensure all projects have 100% control of site through COD.

## Regulatory Restrictions limiting Developers from meeting Site Control Requirements

- PJM cannot support the stakeholder suggestions of cash deposits or demonstration that developer is working toward acquiring property with a Letter of Intent.
- PJM can't allow special exceptions.
- Developer will need to assess the site control risks of the location chosen before moving forward with the project.



## TO Communication of Standard Requirements

- TO will need to post standard requirements for interconnection switchyards.
- If modifications to switchyard locations are required (identified during Phase 2), Developer will have until Submission 3 to acquire modified site.

## Acreage per MW

- If cannot meet posted acreage requirements, PJM will accept PE stamped site plan from the state in which the interconnection is made.

## Site Control is required for:

- 1) Generating Facility
- 2) Generator Lead Lines (Interconnection Facilities)
- 3) Greenfield Interconnection Switchyards

## Exclusion 1:

### Generator Lead Lines:

- Land must be acquired only up to the boundary owned by the Transmission Owner.

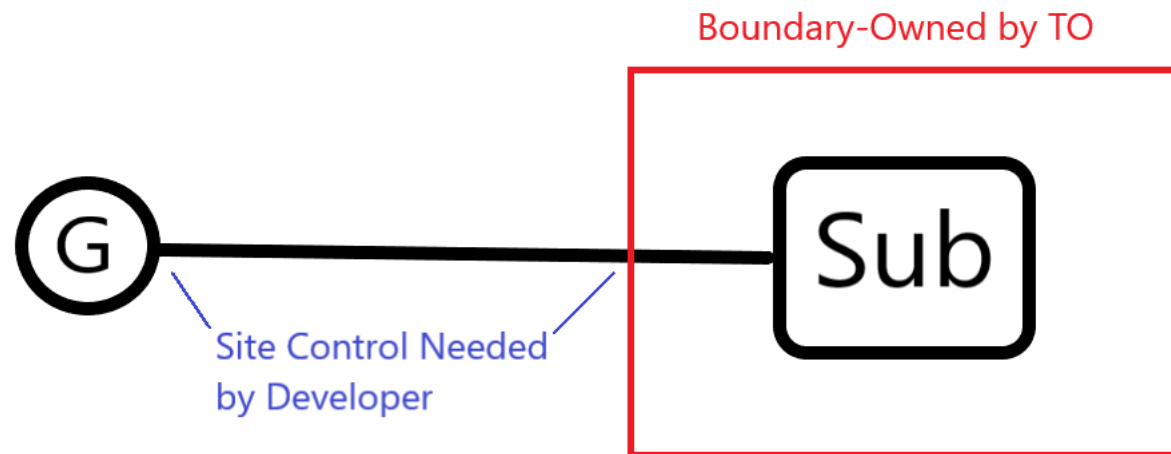

## Exclusion 2:

### Expansion of Existing TO-Owned Substation:

- Additional land that may be needed to expand a substation to accommodate a new generator connection will be secured by the Transmission Owner.
- Generator will be responsible for cost.

Additional Bay at Existing Substation

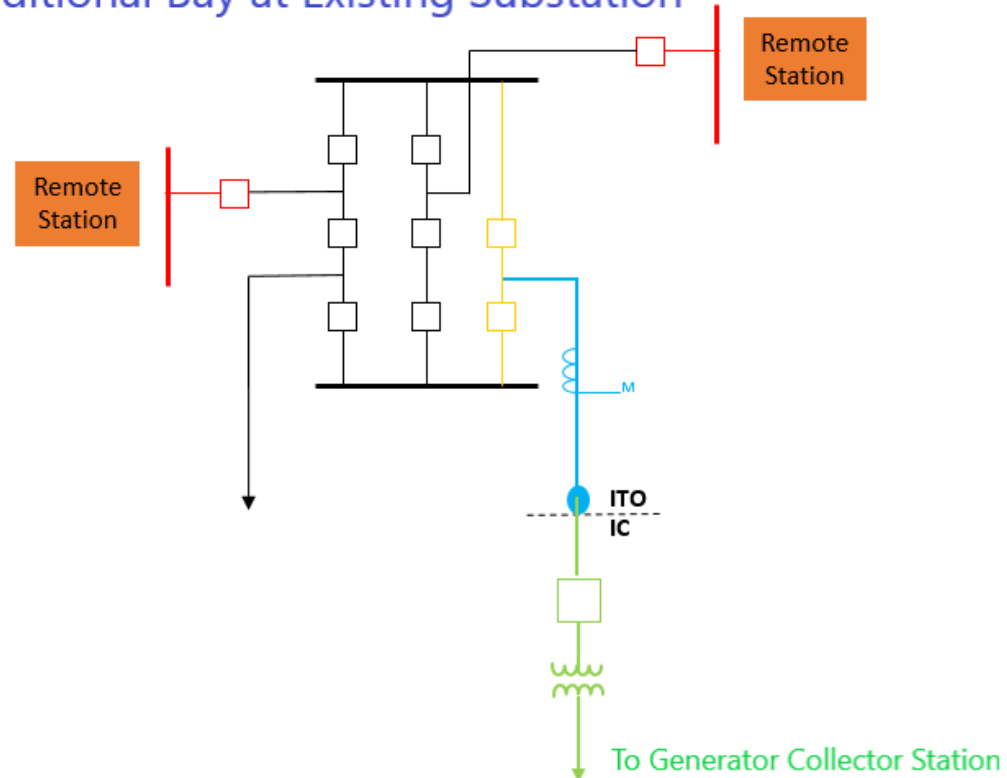



# Study and Readiness Deposits Proposal

Jason Shoemaker  
Manager  
Interconnection Projects

- Proposal adjustments and further clarifications
  - Change to the study deposit to have 10% be non-refundable
  - Separate treatment of Readiness Deposits and Security
  - Readiness Deposit refund timing
  - Proposed forfeited Readiness Deposit disposition

- Update to hold 10% of the study deposit as non-refundable
  - Mirrors the current deposit process
  - Refundable upon reaching commercial operation
  - To be used to fund restudies



# Readiness and Study Deposit Timing Diagram

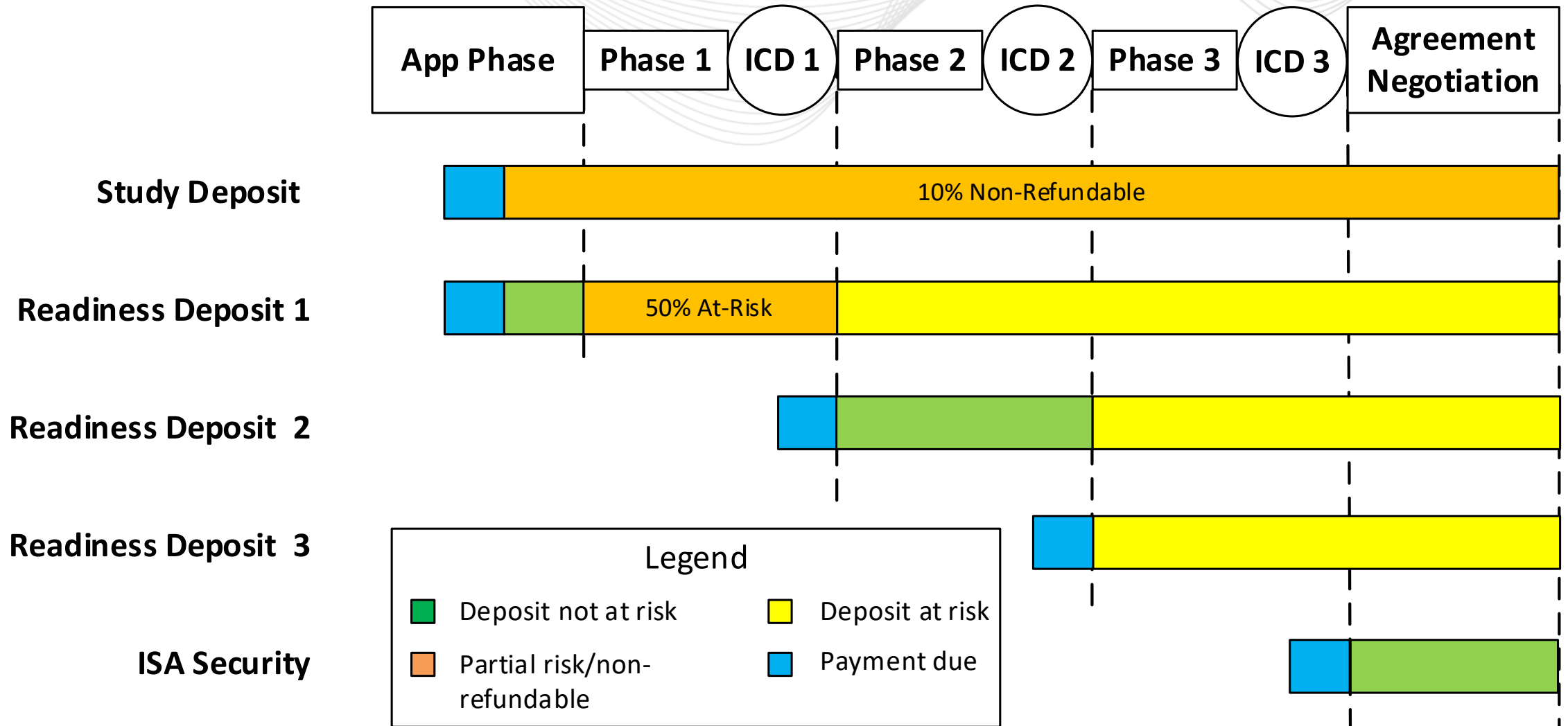

- Study Deposit
  - Covers the study costs
  - 10% non-refundable
  - Due one time at the beginning of the study process
- Readiness Deposit (RD)
  - Funds committed based upon project size and study results
  - Not used to fund studies
  - Refunds subject to study phase and adverse study results test
  - RDs determined at the time they are due; not to be refunded or reduced based upon later project reductions or cost allocation changes
  - Maximum of three RDs due at the project decision points

- Study Deposit

Project Size	Study Deposit
0 - 20MW	\$75,000
> 20 – 50MW	\$200,000
> 50 – 100MW	\$250,000
> 100 – 250MW	\$300,000
> 250 – 750MW	\$350,000
> 750MW	\$400,000

- Readiness Deposit Calculations

- RD1 = \$4,000 per MW
- RD2 = (10% of cost allocation towards required Network Upgrades) – RD1
- RD3 = (20% of cost allocation towards required Network Upgrades) – RD1 – RD2

- RD1 calculation proposed to be based upon the higher of requested Maximum Facility Output or Capacity Interconnection Rights
- RDs 2 and 3 can be zero, but not negative
  - At IC Decision Point 1, total RDs will be the greater of 10% of the cost allocation of required Network Upgrades or RD1
  - At IC Decision Point 2, total RDs will be the greater of 20% of the cost allocation of required Network Upgrades or RD2 or RD1

- At IC Decision 2
  - Increase in Network Upgrade costs allocated to the project of 25% or greater **and** more than \$10,000 per MW from Phase 1 study results
  
- At IC Decision 3
  - Increase in Network Upgrade costs allocated to the project of 35% or greater **and** more than \$25,000 per MW from Phase 2 study results

- Previously proposed that the Readiness Deposit would be rolled into Security at Agreement Negotiation
- Creates concerns by mixing funds held for different purposes
- Proposal updated to separate Security funds from Readiness Deposits
  - Security to be collected in full prior to entering the Agreement Negotiation phase
  - Readiness Deposits to be treated separately and available for refund once all IC Decision Point 3 site control requirements have been met



# Separate Treatment of Readiness Deposits and Security

**Example**  
 100 MW Project  
 \$12,000,000 Network  
 Upgrade Costs

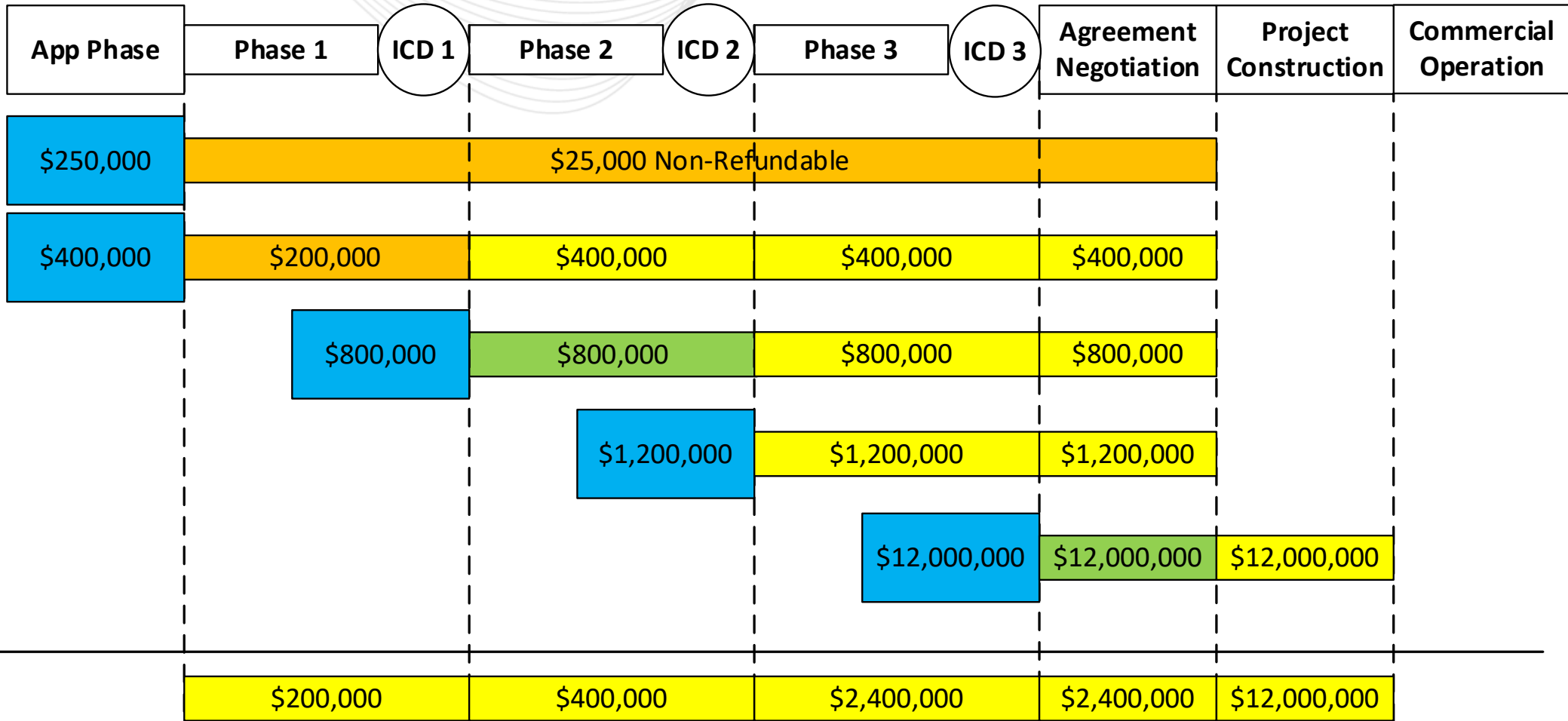

<span style="color: green;">■</span> Deposit not at risk	<span style="color: yellow;">■</span> Deposit at risk
<span style="color: orange;">■</span> Deposit partially at risk	<span style="color: blue;">■</span> Payment due

- Readiness Deposits from withdrawn projects (those that have not triggered the Adverse Study Results Test) will be pooled throughout the Cycle to be used to mitigate late-stage withdraws
- Late-stage withdraws defined as those that occur after Phase 3 Studies are complete
  - Withdraws at the end of the study process provide a small window for those remaining to adjust
  - Significant costs shifts may make remaining projects less viable



- Once all projects in the Cycle have made their decisions, PJM will retool incorporating all withdraws to determine what system Network Upgrades remain necessary
- Underfunded Network Upgrades will be identified
  - Forfeited RDs will be used to backfill
  - Possible that there will not be enough funds in the forfeited RD pool to mitigate all underfunding or there could be a surplus
    - Surplus forfeited RDs will be refunded to developers (pro-rata basis)
  - If after the retool no underfunded Network Upgrades are required, all forfeited RDs will be refunded

Presenters:

Ed Franks, Sr. Lead Engineer,  
Interconnection Analysis

[Edmund.franks@pjm.com](mailto:Edmund.franks@pjm.com)

Lisa Krizenoskas, Sr. Lead Engineer,  
Interconnection Projects

[Lisa.krizenoskas@pjm.com](mailto:Lisa.krizenoskas@pjm.com)

Jason Shoemaker, Manager,  
Interconnection Projects

[Jason.shoemaker@pjm.com](mailto:Jason.shoemaker@pjm.com)



Member Hotline

(610) 666 – 8980

(866) 400 – 8980

[custsvc@pjm.com](mailto:custsvc@pjm.com)

# Appendix

## Interconnection Reform Task Force PJM Solution Proposal Framework

- Framework was created by PJM staff and management over several sessions
- The framework borrows heavily from interconnection processes in other RTOs
- Full solution details in the PJM Solution proposal matrix.

- Ideal timing not to exceed 2 years
- Cost and study construct should be cluster/cycle based and convert from first in/first out processing to first ready/first out processing
  - Readiness demonstrated by site control and financial milestones
- Subsequent cycle management should be assessed based on completion of a certain point in the prior cycle to minimize backlog
- Provide customers with more actionable information, earlier in the process
- Attempt to merge all other application types into new process
- State jurisdictional projects should have appropriate milestones to enter into an interconnection agreement from the Transmission Owner / Distribution Provider prior to receiving a Wholesale Market Participation Agreement

- Remove incremental financial rights for generators for simplification and due to removal of first-to-cause construct. Add a parallel process for generators seeking to receive these rights
- Remove other generation interconnection request forms (Attachments Y & BB) for simplification
- Remove or reduce scope of pre-application process
- Make project changes predictable from a process viewpoint and automatic to provide certainty to customers
- Allow off-ramps for generators proceeding through the process at various decision points
- Remove Optional Interconnection Study process

Total time per cycle – 710 days

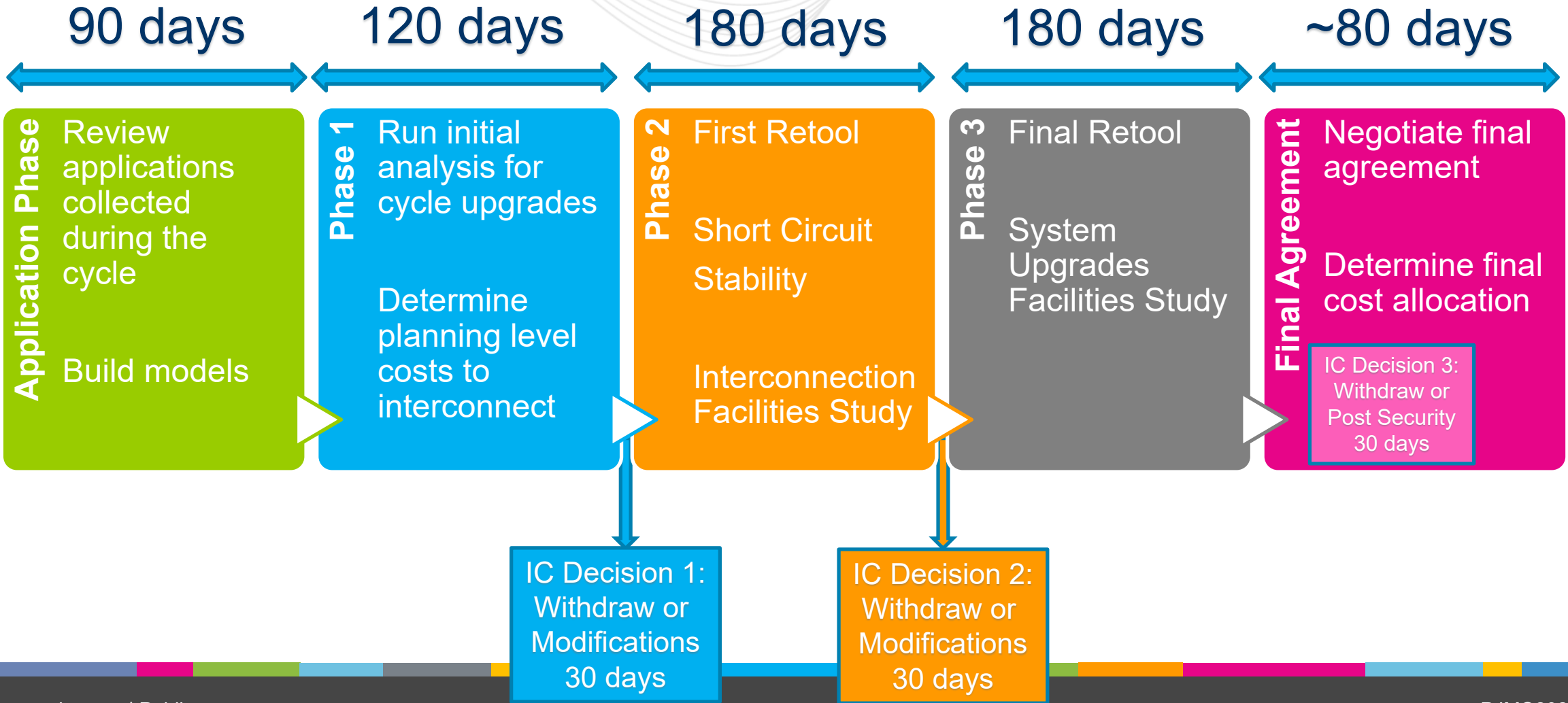

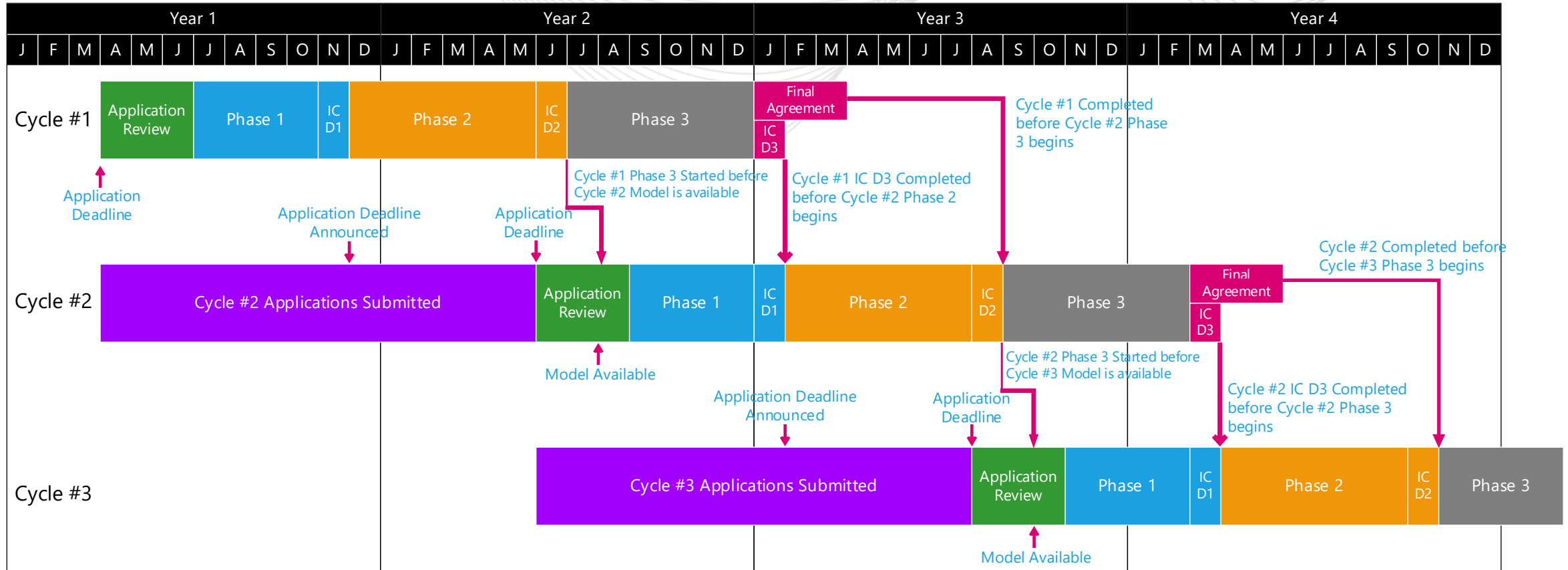

## Subsequent Cycle Start

- Application deadline of the subsequent cycle will be announced 180 days in advance at the conclusion of Phase 1 - IC D1 of the most recent cycle.
- Only completed applications received by the Application Deadline will be considered for the upcoming Cycle.
- Applications will only be reviewed during the Application Review period.
- Phase 1 of a subsequent cycle will only start after Phase 3 of the previous cycle has started AND all Application Review period activities have been completed AND the model have been made available for a 30 day review. Phase 2 of a subsequent cycle will only start after IC D3 have concluded. Phase 3 of a subsequent cycle will only start after the prior cycle has concluded.



- Single closing period for kicking off a cycle
- Allow a defined window to review all active applications from the open cycle
  - Do not review applications “mid-stream”
- Single application agreement with a unified study deposit and milestone payments
  - Typical data required + dynamic data up front
  - Shared facilities agreement required if connecting behind another POI
- Site control for generating site required and will be revisited throughout the process
- Single Point of Interconnection only
- Study Deposit (see table) + Readiness payment (\$4,000 / MW)
- Load Flow study model provided at least 30 days prior to the start of Phase 1

- Analysis Provided
  - Summer Peak load flow
  - Light load season load flow
  - This analysis will be the equivalent of an Impact study analysis at full commercial probability and DC & AC
- Interconnection Facilities
  - Scope, cost, schedule – planning desk-side estimate
- System Upgrades
  - Scope, cost, schedule – planning desk-side estimate
  - Cost allocation
- Results provided as a single cycle format (e.g. spreadsheet)

- Changes permitted:
  - Reduce the output of the request (both MFO & CIR)
    - Up to 100% of requested MFO and/or CIR value
  - Point of Interconnection finalized
    - Location along transmission line or
    - Substation breaker position
  - Equipment changes
  - Withdraw project
- Customer Requirements:
  - Decide whether direct connection network upgrades will be subject to Option to Build
  - Provide 100% generation facility site control again
  - Provide 50% of site control for customer interconnection facilities (gen-tie) to the Point of Interconnection & new interconnection switchyard (if applicable)
  - Provide evidence of air & water permits if applicable
  - State jurisdictional interconnections to provide evidence of entering the state's interconnection process (if applicable)
  - Readiness Payment #2 (10% of network upgrade costs)
- Off ramp for projects that do not require a Facilities Study and do not contribute to the need for network upgrades

- Analysis Provided
  - Retool load flow results
  - Short circuit study
  - Initial affected system study results (if needed)
  - PJM to notify developer of requirement to enter into an Affected System Study Agreement (if needed)
  - Stability analysis
- Interconnection Facilities
  - Transmission Owner to perform Facilities study
- System Upgrades
  - Scope, cost, schedule, & cost allocation

- Changes Permitted:
  - Reduce the output of the request (both MFO & CIR)
    - 10% of the amount studied for Phase 2
  - Equipment changes under permissible technology changes
  - Withdraw project
- Customer Requirements:
  - Readiness Payment #3 (20% of network upgrade costs)
  - Enter into Affected System Study Agreement if applicable
- Off-ramp for projects that only have interconnection facilities and do not contribute to the need for network upgrades. They can proceed directly to a final agreement

- Analysis Provided
  - Final retool of all Phase 2 analyses
  - Final affected system study (if needed)
- Interconnection Facilities
  - Target back-feed dates
- System Upgrades
  - Final cost allocation
  - Transmission Owner Facilities study
- Agreement Related
  - Draft ISA/CSA
  - Security calculation

- Changes Permitted:
  - Withdraw project
  
- Customer Requirements:
  - Post security for upgrade cost allocation and indicate the project will proceed to a final agreement.
  
  - Developer to provide 100% site control within 6 months of final agreement execution for the following:
    - generation site
    - interconnection switchyard
    - customer interconnection facilities to the POI
  
  - Provide evidence of necessary state, county, & local permits or a milestone will be created for the final agreement

- Negotiate final agreement details including milestones, construction schedule, site control review, and Transmission Owner input
- True-up final security as required for projects that may have withdrawn during IC Decision 3
- Perform any remaining retool necessary to ensure system upgrades are still needed
- No ability to suspend a project - construction delays will be handled with milestone extensions for issues outside of the developer's control
- 15 business days to execute once tendered



- Generation Interconnection
  - Attachment N, Y, BB



- Transmission Interconnection
  - Attachment S



- Long Term Firm Transmission Service
  - Attachment PP



- Upgrade Request
  - Attachment EE



- Surplus Service Request
  - Attachment RR



Merge into new cycle process

Parallel Process

Status Quo

# Appendix

## PJM Proposed Transition Options

- Review PJM's recent historical throughput
- Establish assumptions upon which the options are based
- Walkthrough the transition options



# Interconnection Queue Throughput: 2020-2021

## Feasibility Study

## System Impact Study

## Facilities Study

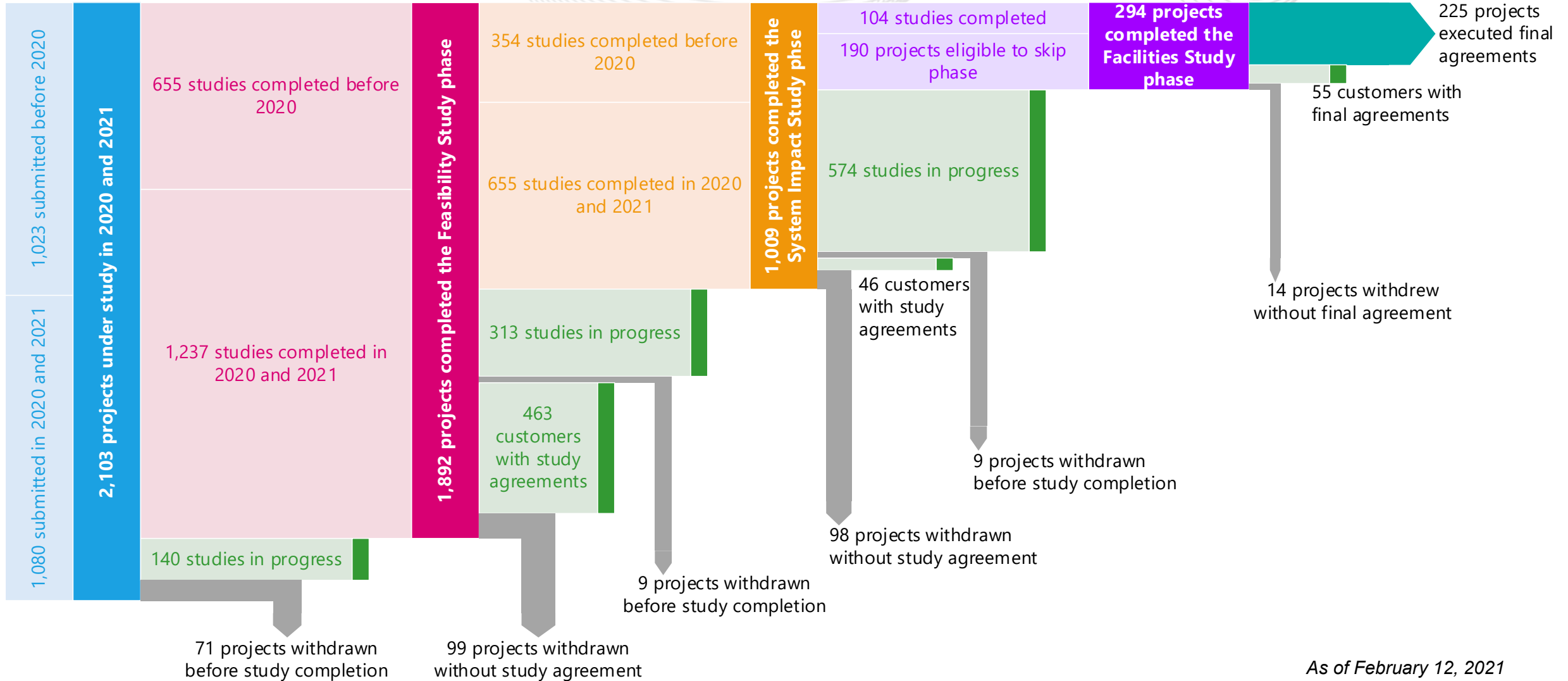

As of February 12, 2021

- The effective date of the transition is October 1, 2022 based on the current work plan
- PJM expects to complete queues through the end of AD2 under the existing process by the transition date. Projects will be worked under the current process until the effective date of the transition (“business as usual”).
- After the transition date, based on historical throughput and recent re-prioritization, PJM expects to be able to complete approximately 300 projects per year that remain in the existing process. Complete indicates entering into a final agreement or withdrawal.

- PJM will not accept new interconnection requests from the effective date until the new process begins. The A11 queue may or may not be open depending on the timing of the filing.
- All options offer treatment on interconnection projects that have already received at least one interconnection study (AG1 and prior) which amounts to 1,233 projects.
- All projects will be subject to the new readiness requirements at the appropriate decision windows unless otherwise specified they are under the existing process
- Projects that have received an ISA/WMPA for execution or have a signed agreement will not be subject to the transition

- AG1 and prior projects (1233) – Remain in current process
- Transition Cycle #1 - AG2 projects (654)
  - Start in Application Review and provide load flow model
  - Require to post RD #1 and meet site control requirements to enter Phase 1
- New Process Cycle #1 - AH1 & Beyond projects (653+)
  - Start in Application Review and provide load flow model
  - Require to post RD #1 and meet site control requirements to enter Phase 1
- New Process Cycle #2
  - Begin accepting applications and start new process

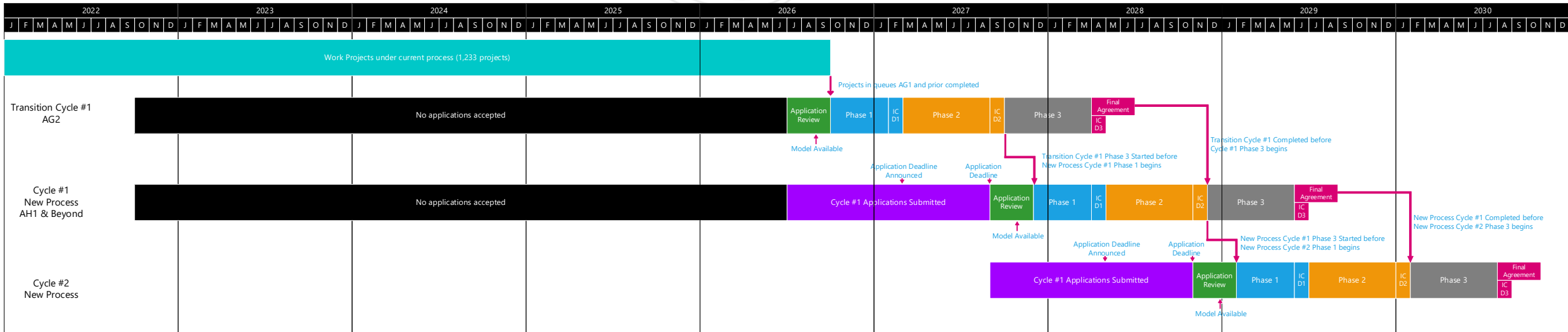

All queues AG1 and prior being processed under the existing rules with no adjustments



- Offers projects that have already received a study (AG1 and prior) no changes from the PJM process from when they entered the queue
- Lengthy transition time to the new process

- AD2 and prior projects (123) – Remain in current process
- Transition Cycle #1
  - AE1 and AE2 projects (248) & AF1 and AF2 projects (450) & AG1 projects (412)
  - Start in IC Decision #1 after providing retool results.
  - Require to post RD #2 and meet site control requirements to enter Phase 2.
- Transition Cycle #2 - AG2 projects (654)
  - Start in Application Review and provide load flow model
  - Require to post RD #1 and meet site control requirements to enter Phase 1
- New Process Cycle #1 - AH1 & Beyond projects (653+)
  - Start in Application Review and provide load flow model
  - Require to post RD #1 and meet site control requirements to enter Phase 1
- New Process Cycle #2
  - Begin accepting applications and start new process

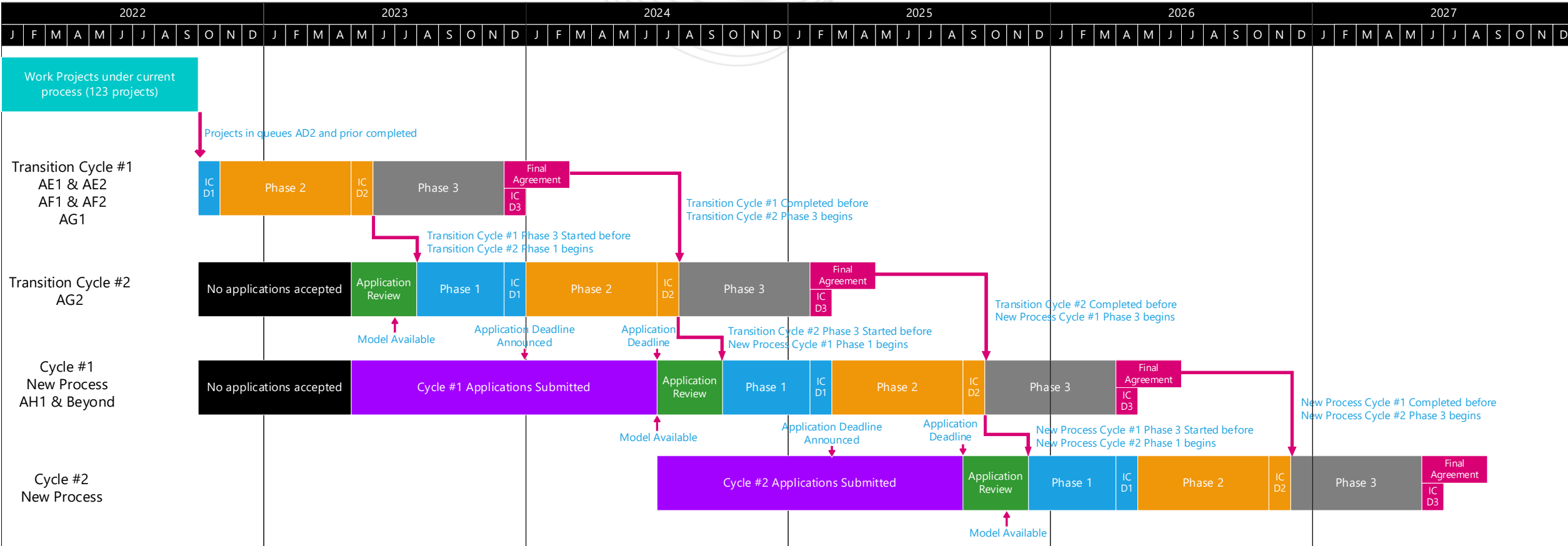

- Allows PJM to continue to work oldest projects under existing rules (i.e. projects that were submitted in the 2017/2018 time frame)
- Allows to transition to the new process by accepting applications within 1 year of effective date
- Co-mingles AE1 – AG1 queues which will lead to different results

- AD2 and prior projects (123) – Remain in current process
- Transition Cycle #1 - AE1 and AE2 projects (248)
  - Start in IC Decision #2 after providing retool results.
  - Require to post RD #3 and meet site control requirements to enter Phase 3.
- Transition Cycle #2 - AF1 and AF2 projects (450)
  - Start in IC Decision #1 after providing retool results.
  - Require to post RD #2 and meet site control requirements to enter Phase 2.
- Transition Cycle #3 - AG1 projects (412)
  - Start in IC Decision #1 after providing retool results.
  - Require to post RD #2 and meet site control requirements to enter Phase 2.

- Transition Cycle #4 - AG2 projects (654)
  - Start in Application Review and provide load flow model
  - Require to post RD #1 and meet site control requirements to enter Phase 1
- New Process Cycle #1 - AH1 & Beyond projects (653+)
  - Start in Application Review and provide load flow model
  - Require to post RD #1 and meet site control requirements to enter Phase 1
- New Process Cycle #2
  - Begin accepting applications and start new process

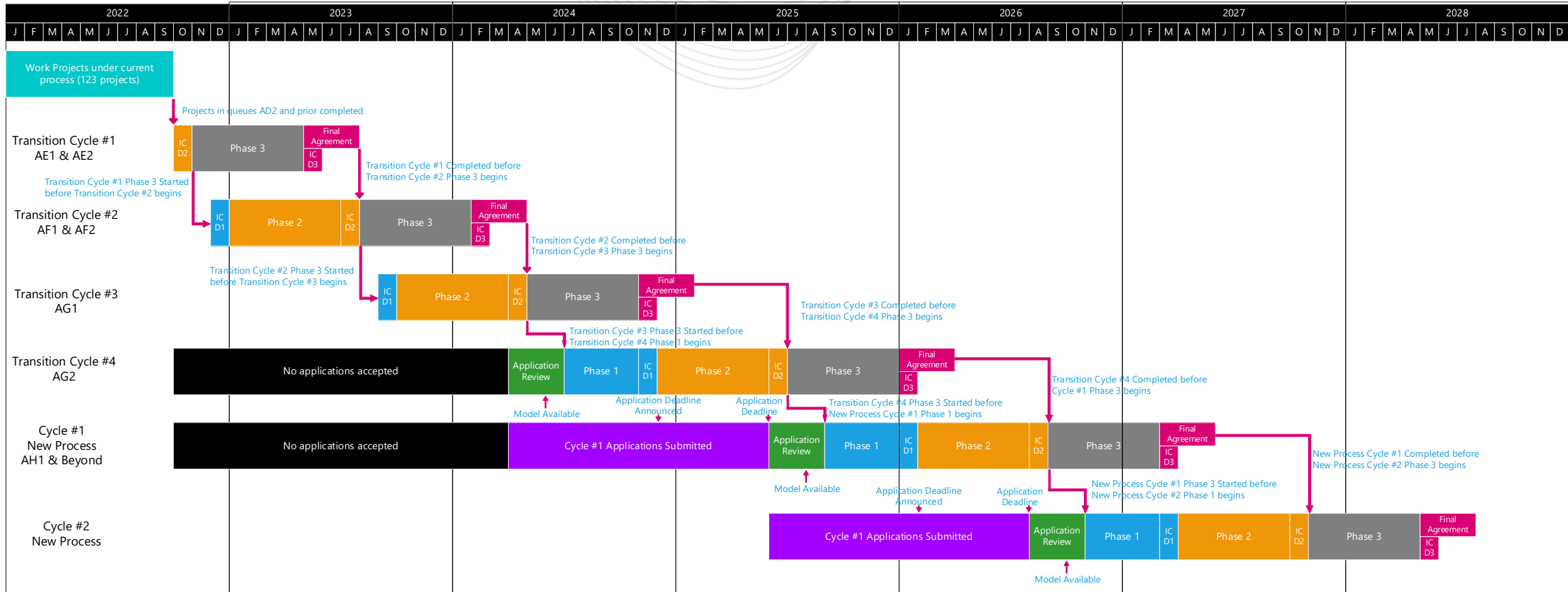

- Allows PJM to continue to work oldest projects under existing rules (i.e. projects that were submitted in the 2017/2018 time frame)
- Allows to transition to the new process by accepting applications within 3 years of effective date
- Segments existing projects more granularly to smooth processing of retools and Facilities studies
  - Allows existing queues to be processed on their current base cases which alleviates case transition issues
  - Lessens co-mingling of queues in new process
- Creates a longer period of time where PJM does not accept new applications in order to update tools



- AD2 and prior projects (123) – Remain in current process
- AE1 through AG1 projects (1,110) given 60 days after effective date to decide to remain with the existing cost allocation rules or move to Transition Cycle #1
  - No jumping between the existing cost allocation rules and Transition Cycle #1. The decision made during the 60 day window is binding. If the project does not meet the requirements of either process timely, it is withdrawn.
  - Retool results for each set of queues will be available prior to a decision window (e.g. AE1 – AE2 will be retooled with updated cost allocation prior to the 30 day IC D2 window).
- Remain with existing cost allocation rules – (?)
  - Projects that elect to remain are required to post the readiness deposits and meet the site control requirements of the appropriate decision window in the transition diagram
  - Subject to new agreement execution timing (15 business days)
  - Project modifications not permitted.
- Transition Cycle #1 – (?)
  - AE1 through AG1 projects that did not elect to remain under the existing cost allocation rules lose their queue priority and are “re-queued” after the latest project that elected to stay under the existing cost allocation rules but before AG2 projects
  - Start in IC Decision #1 after providing retool results.
  - Require to post RD #2 and meet site control requirements to enter Phase 2.

- Transition Cycle #2 - AG2 projects (654)
  - Start in Application Review and provide load flow model
  - Require to post RD #1 and meet site control requirements to enter Phase 1
- New Process Cycle #1 - AH1 & Beyond projects (653+)
  - Start in Application Review and provide load flow model
  - Require to post RD #1 and meet site control requirements to enter Phase 1
- New Process Cycle #2
  - Begin accepting applications and start new process

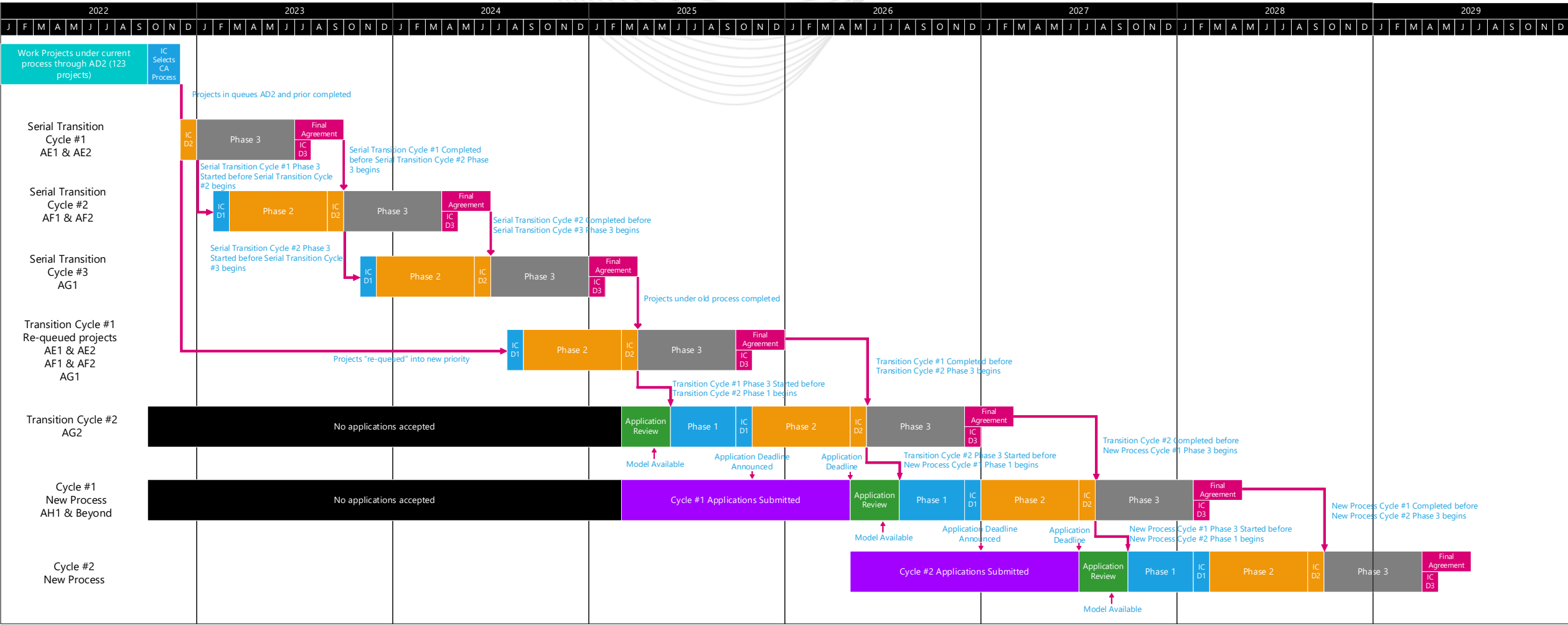

- Allows PJM to continue to work oldest projects under existing rules (i.e. projects that were submitted in the 2017/2018 time frame)
- Allows to transition to the new process by accepting applications within 3 years of effective date
- Permits customers to elect between existing cost allocation option or the new cycle based method
  - Allows existing queues to be processed on their current base cases which alleviates case transition issues
  - Invalidates results for projects that have been “re-queued”
  - Time to transition to new process based on how many projects elect to remain under the old cost allocation rules.